

Westalee
DESIGN

**Machine Quilting
with Rulers
using a
Domestic Sewing
Machine**

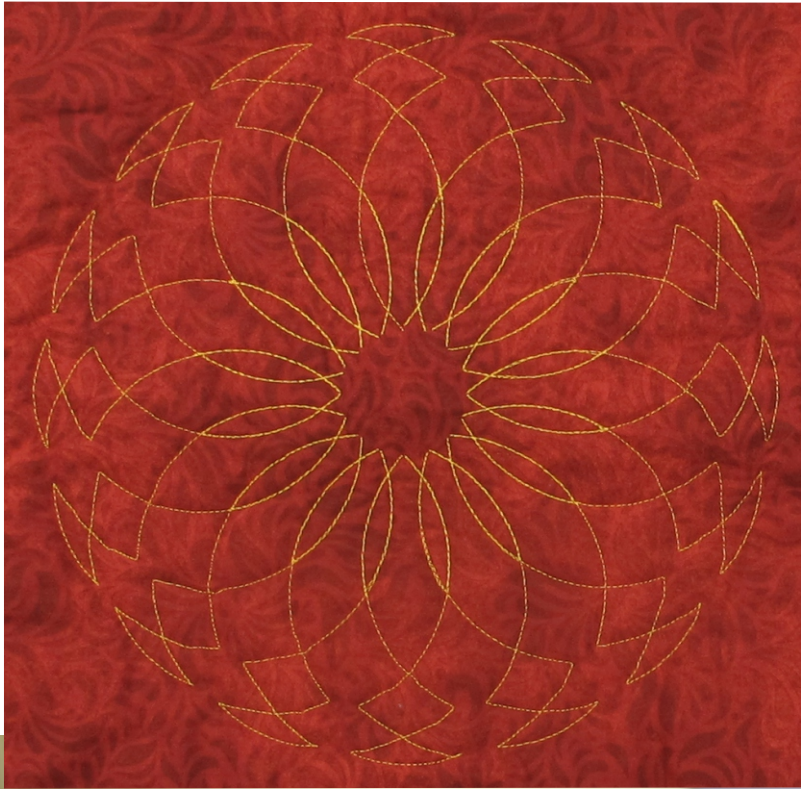



If you already have
the Westalee Ruler Foot
and would just
like to see our current
selection of templates
[click here](#)

**Copyright © 2016, 2019 The Cotton Patch Limited
1283-1285 Stratford Road, Hall Green, Birmingham B28 9AJ**

**T. 0121 702 2840, E. mailorder@cottonpatch.co.uk
W. www.cottonpatch.co.uk**

Free Motion Quilting for Everyone

Why a 1/2"?

The Westalee Ruler Foot is exactly 1/2" in diameter. This means that when you move the foot around a template your machine will always stitch a consistent 1/4" away from the edge of the template which will help when you plan and position your designs.

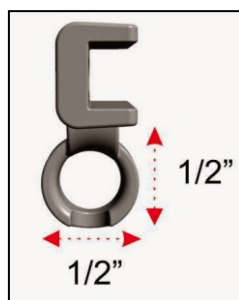

Please note that other quilting feet will only work with Westalee templates if they are a true 1/2" foot (many are not!)

The designer, Leonie West, set out with the aim of making these rulers accessible to as many domestic machine users as possible. This means there are five different types of foot available to cover the many different makes of sewing machine. So, your starting point is selecting the right foot for your machine.

There are five types of Foot available: Low Shank, High Shank (the two most common), Medium Shank, High Shank Special and Slant Shank. If your machine is not in the list on the next page it is most likely a Low or High Shank.

Use the following method to determine which you have. Remove the foot from the presser foot bar. Lower the bar and then measure the height from the needle plate to the centre of the screw hole.

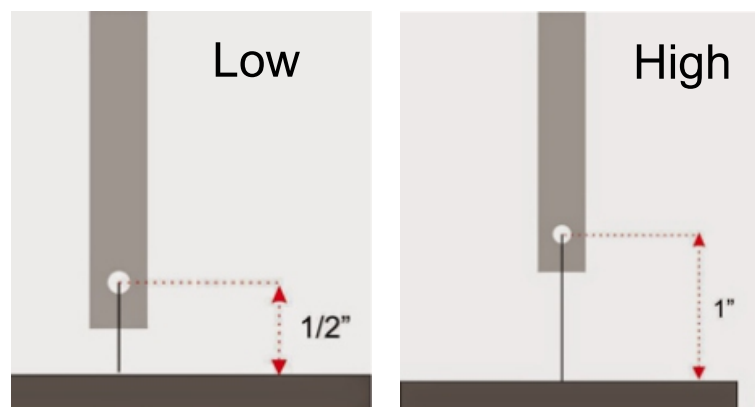

Below are the feet for Low and High shank machines.



1/2" round Ruler
Foot Low Shank

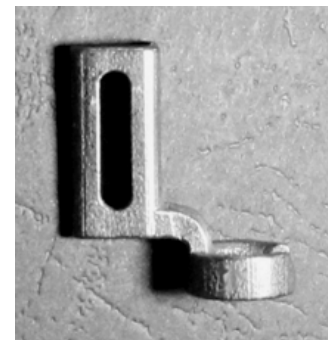

1/2" round Ruler
Foot High Shank

As an extra measure, when you order online, you can enter your machine make and model number and we will check you have selected the right one.

Medium Shank, High Shank Special & Slant Shank

Some machines require a different shank fitting to the standard Low and High. If your machine is listed here you will need to buy one of these feet. Please note - this list is not comprehensive as new machines are continually released.

High Shank Special (HSS) Ruler Foot

- Brother PQ1300 PQ1300 PQ1500S
- Babylock BLQP BL500A
- Janome 1600P 1600P-DB 1600-QC, 1600P-QC
- JUKI DDL-227 DDL-555 DDL-8700 TL-98E TL-98P TL-98QE TL2000Qi TL2010
- Pfaff 1200 Grand Quilter
- Husqvarna Mega Quilter
- Singer 2OU 31-15, 1191-D300A



Medium Shank (MS) Ruler Foot for Pfaff Machines

Creative Sensation Pro, Creative Sensation, Creative Vision, Creative Performance, Creative 4.5, 4.0, 3.0, 2.0, Performance 5.0, Quilt Expression 4.2, 4.0, Expression 3.5, 3.2, 3.0, 2.0, Expression 150.

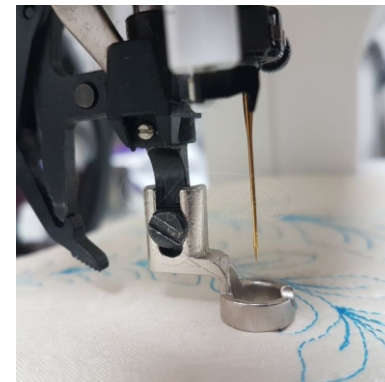

Slant Shank (SS) Ruler Foot

This Foot has been designed specifically for use on Singer Slant Shank machines.

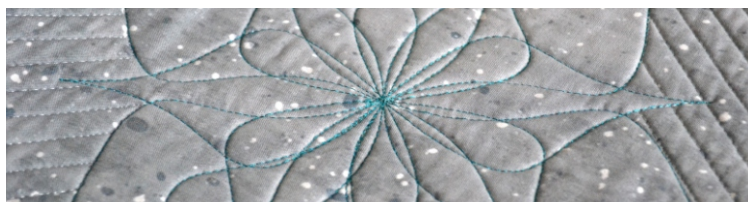

When using a Medium Shank Foot for your Pfaff machine you will need to use either the Spring Free Motion setting for the Expression and Creative range of machines or, put your presser foot into the mezzanine position - free motion position - darning position (refer to your manual).

[Click here to purchase the Westalee Ruler Foot](#)

Bernina Sewing Machines

Leonie designed the **Medium Shank Ruler Foot** specifically with the Bernina 7 and 8 series in mind as it allows the foot to sit lower to the plate and helps remove the hop (you can get away with a Low Shank Foot for the 7 series, but Westalee do recommend that you purchase a Medium Shank Foot).

All other Bernina machines require a Low Shank Ruler Foot

To use a Westalee Ruler Foot on a Bernina you need an Adapter
Bernina Sewing machines have a style of foot attachment that is very different to other brands. To be able to attach a Westalee Ruler Foot to your Bernina you will need to fit an adapter. We have two to choose from:

Bernina #77 Ruffler Foot Adapter (12579)

This adapter only works with new style Berninas with a built in needle threader. It is made to use with a Ruffler foot, but it is also a good option for the Westalee Low or Medium Shank Ruler Foot.



Bernina #75 Low Shank Adapter, Old Style (8036)

If you own a 1630 or earlier model (for example, 1030, 1130, 1230 etc.) you will need this adapter. Similar to the #77, it is slightly longer and so it is less well suited to projects using a high loft wadding.



Bernina 7 and 8 Series settings recommended by Westalee Design

7 Series with a Medium Shank Ruler Foot - Presser Foot Pressure setting "minus 15"

7 Series with a Low Shank Ruler Foot - Presser Foot Pressure setting "minus 4"

8 Series with a Medium Shank Ruler Foot - Presser Foot Pressure setting "minus 25" and select Foot #9

[Click here to purchase a Bernina Adapter](#)



Ordering Templates for Your Bernina Online - Help us get it right!

We expect most Bernina users to be ordering Low Shank Templates, but if you have the #72 you will need to order High Shank templates. When you order please let us know what foot you are using when prompted for your Make and Model number. For example type 'Bernina 750QE + #72 foot' or 'Bernina 750QE + Westalee'

We do not sell the Bernina #72 foot, but if you are interested in this option you can find out more in this video.

The Bernina #72 Ruler Foot - an Alternative to the Westalee Ruler Foot

Bernina have developed their own Ruler Foot specifically for Bernina machines. This, like the Westalee Ruler Foot is a true 1/2" round foot, which means that you can still make use of the variety of Westalee Rulers.

Important - Bernina have designed the foot to be used with Longarm (6mm) templates and have a small selection of rulers at this thickness. However, because the #72 foot is adjustable it is quite possible to use Westalee High Shank templates (4.5mm) and many quilters have already done so with great success.

If you decide to use High Shank templates with the Bernina Ruler Foot #72 please ensure that you adjust the height of the foot correctly before you begin quilting. You do not want the ruler to have any chance of slipping under the foot and hitting the needle which could happen if the foot is set too high.



Purchasing the Ruler Foot

Every *Starter Set* contains a Foot packaged with an Arc Template (left) whether it is Low, High, Medium, Special or Slant shank. The package also includes “Stable Tape”, a strip of grip tape that helps stop the template slipping on the fabric.

The Arc Template is an essential ruler for straight line stitching and gentle curves. This tool is recommended for all quilters and by packaging it with the Foot it removes the difficult decision of which of the many templates you should start with!

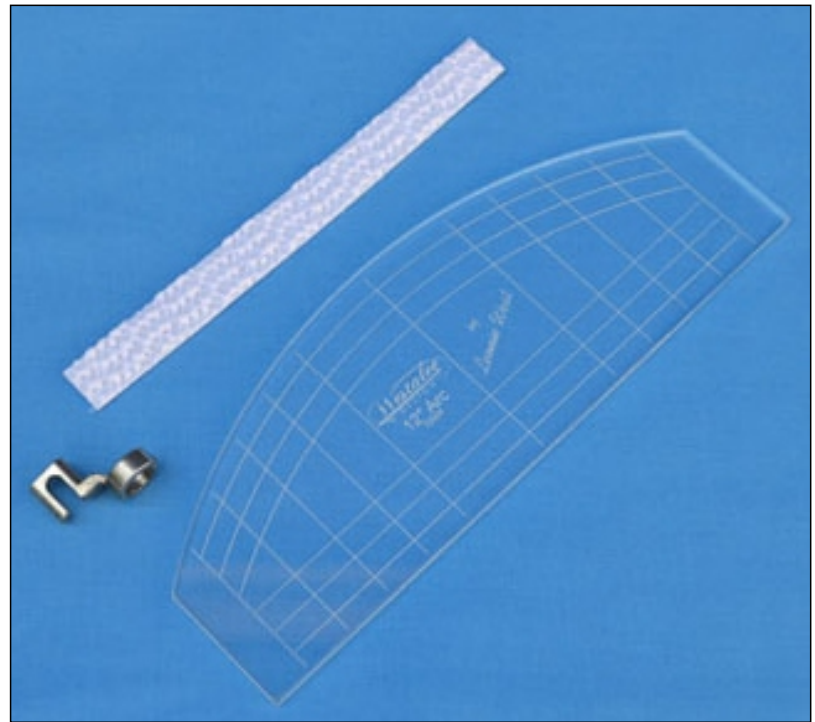

The instructions in the pack show how to attach the Ruler Foot, or you can watch the video below.



[Click here to purchase the Westalee Ruler Foot](https://youtu.be/USRCHZ9njHM?list=PL1m3VMFNLxGBAKChD2vrM9a ejLjXyiHmV)

It is now possible to buy any Ruler foot on its own without the Arc Template. This is a useful option if you own more than one machine that uses the same templates.



The Arc Template can also be purchased separately. Again, this is a useful option if you already have a compatible 1/2" machine quilting foot and just need the ruler (Low Shank - 12689, High Shank 12670). Note that it is cheaper to buy the Starter Set than these two items separately.



The Arc Template is an invaluable tool for adding straight lines and gentle curves to your designs.

Five become Two!

It is important that you purchase the right thickness of template to go with your selected Ruler Foot. Fortunately, from the five Ruler Foot options there are only two template thicknesses to choose from for domestic machine users - Low (3mm) and High (4.5mm). Note that Westalee also produce 6mm templates for owners of Longarm machines. We do not carry many of these as a stock item, but you can [click here](#) to learn more.

(Please note that the words “ruler” and “template” are interchangeable)

If your machine requires a **Low (LS)**, **Medium (MS)** or **Slant (SS)** Shank Ruler Foot you must always buy **Low Shank** templates.



If your machine requires a **High (HS)** or **High Shank Special (HSS)** Ruler Foot you must always buy **High Shank** templates.



Exploring a New World of Quilting Possibilities



The essence of the Westalee Ruler concept is that it enables you to free motion quilt, but in a controlled way. If you have always shied away from free motion quilting then the Westalee system now offers you the opportunity to be creative, but to be guided in the process.

The rest of this ebook explains the different types of rulers and templates we sell with videos on how to use some of them.

If you don't have a specific template design in mind then we recommend you purchase **Sampler Set 1** with your Ruler Foot. Leonie has produced videos of how the various templates in this Sampler Set are used and we have included these on the following pages. It is worth watching these to get a feel for how the different templates are used. The Sampler Set also offers lots of potential by combining these templates in different ways to create new designs.

You can purchase Sampler Set 1 and a Ruler Foot as individual items on our website or we have a “**Machine Quilting Starter Set**” - a boxed set that includes both of the above plus a 12½” Crosshair Square ruler.

The set also includes a free **Spacing Gauge** (11829, right) worth £7.50. For more information on the Cross Hair Square [click here](#) or go to the accessories section.



[Click here to purchase the Machine Quilting Starter Set](#)

Sampler Template Set 1



Sampler Template Set 1

This Sampler set is a great starting point for your free-motion quilting as it includes 6 templates with lots of design potential to get your creative juices flowing!

The Set includes:

- 1 x 6" Spiral
- 1 x Spin-e-fex No.4
- 1 x Circles on Quilts Spinning Wheel No.36
- 1 x 4" Arc
- 1 x Clamshell
- 1 x bonus 2" Inside Circle
- 2 x Pins

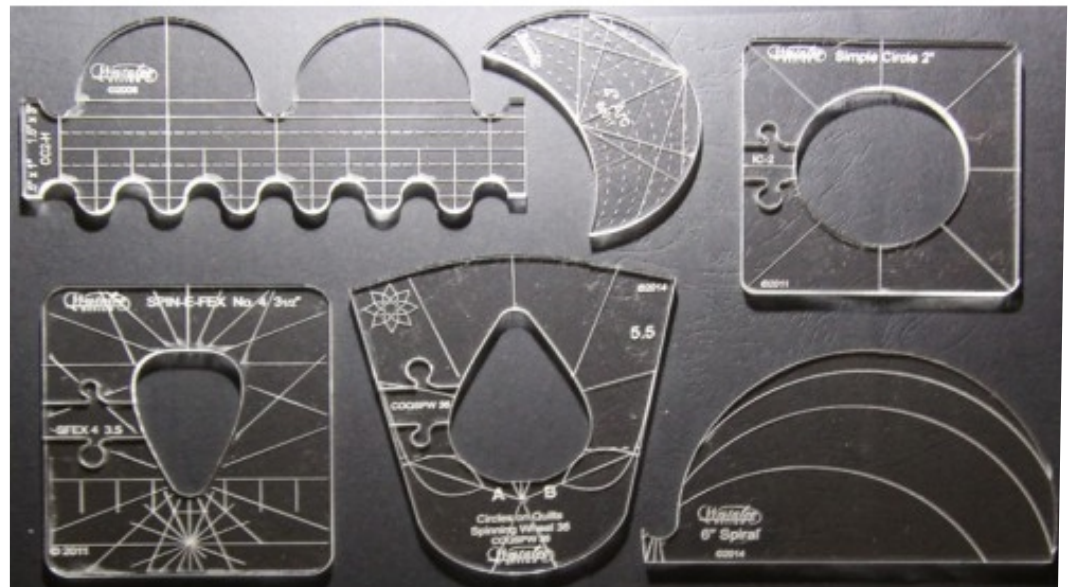

On the next two pages show some examples created with the templates. More instructional videos for other templates are available on YouTube, search on “Westalee Design Template Videos”.

Templates in Sampler Set 1

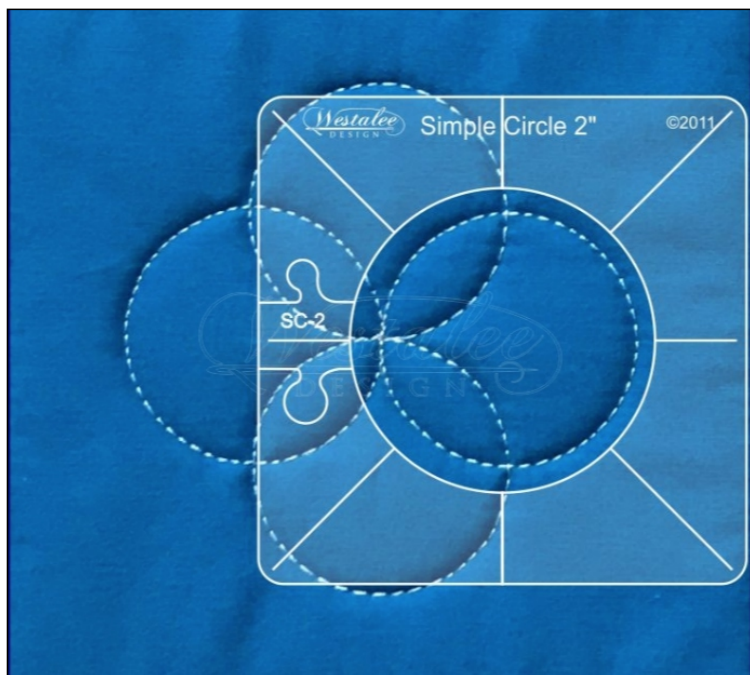

Simple Circle 2"

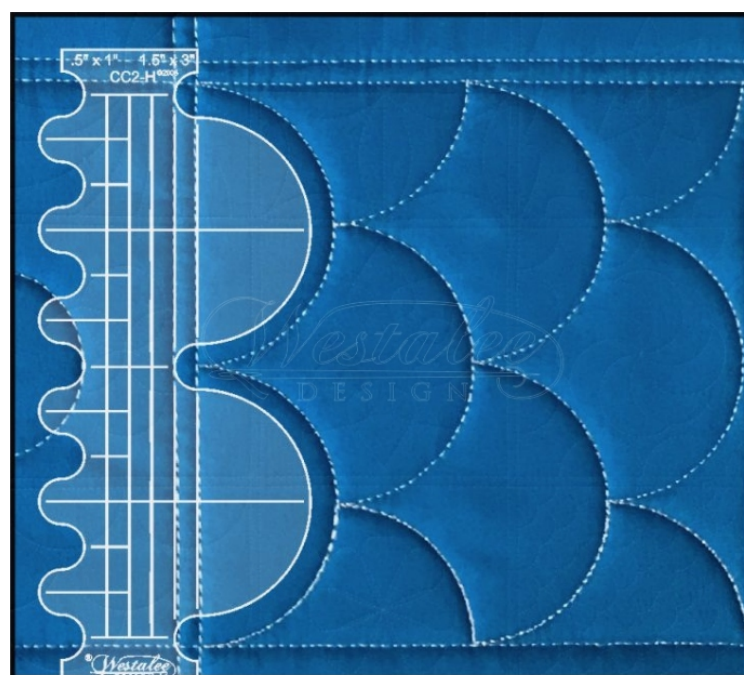

Clamshell



Video: using the Simple Circle



Video: using the Clamshell



The 4" Arc is a great tool for working in small areas.

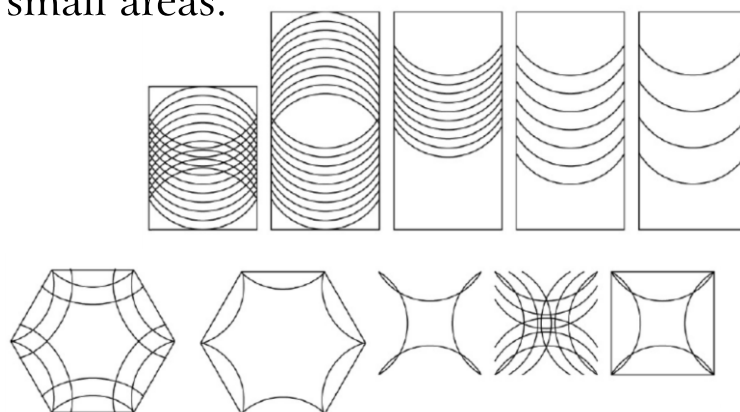

Templates in Sampler Set 1

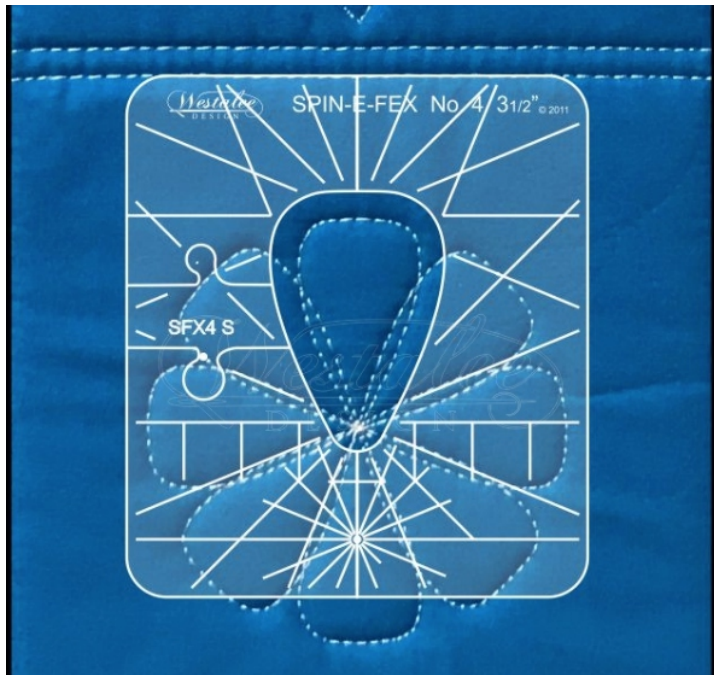

Spin-e-Fex No.4



Spinning Wheel No.36

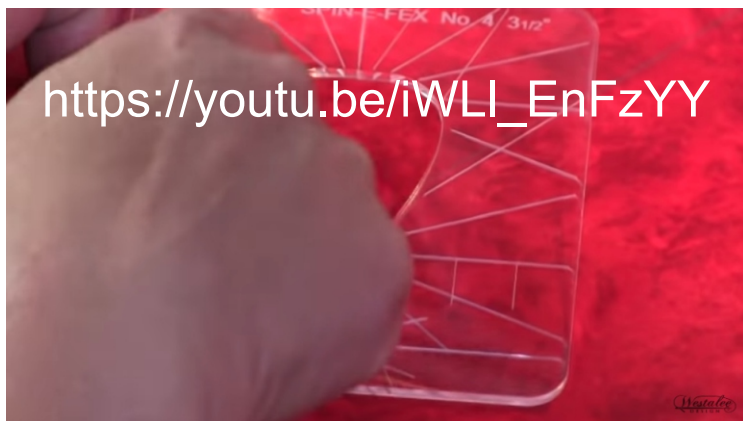

Video: using Spin-e-Fex No.4

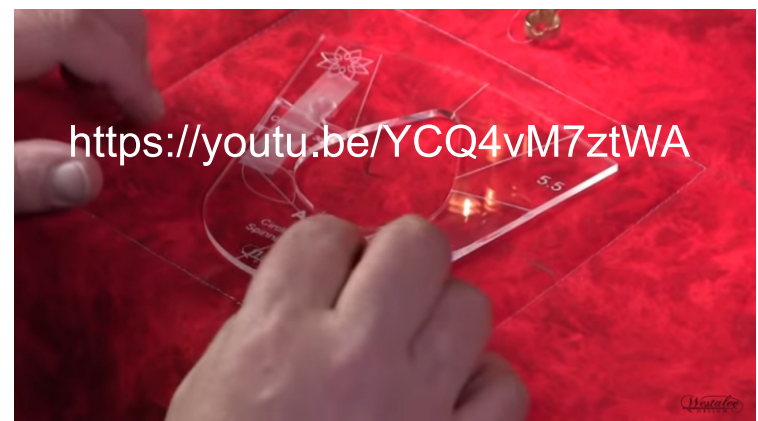

Video: using Spinning Wheel No.36

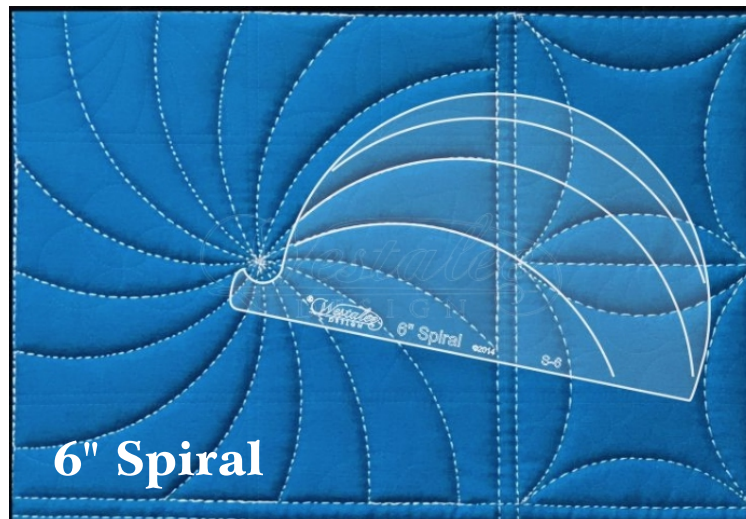

6" Spiral



6" Spiral Template from the Sampler Set of Templates

Video: using the 6" Spiral

Click here to purchase HIGH Shank or here for LOW Shank



This fabulous, contemporary quilt was designed and quilted by Angela Attwood. The quilting designs have been constructed using the Arc Template and templates from Sampler Set 1. It is a wonderful example of how much design potential there is from these templates.

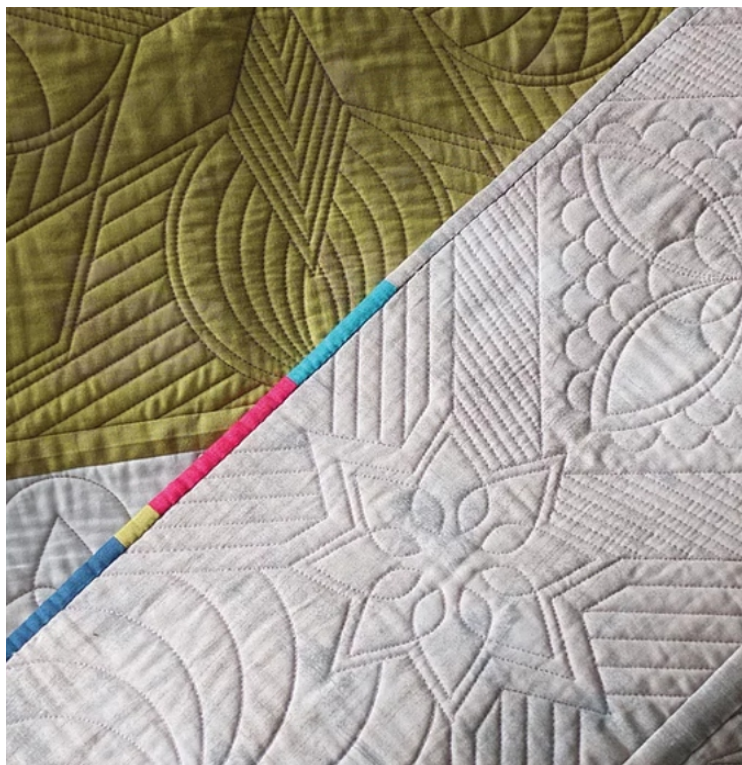
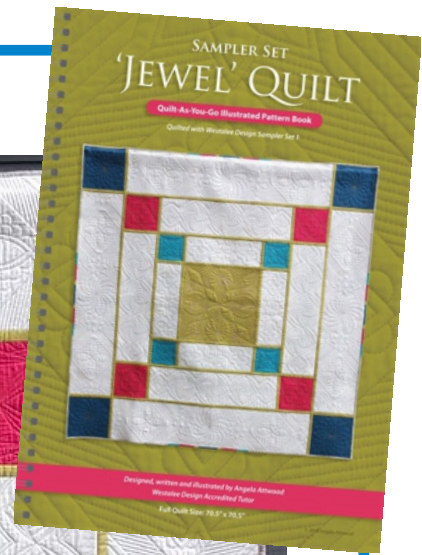

Angela is local to the Cotton Patch and runs a variety of workshops teaching how to get the most out of the Westlee Ruler Foot and templates. To find out more about Angela's courses [click here](#).

Angela is one of three Westlee Accredited teachers in the UK. For a current list of teachers running courses on free motion quilting on a domestic sewing machine or to contact a teacher to enquire about courses [click here](#).

If you are just starting your journey into free-motion quilting with Westalee this next section outlines what to look for in a sewing machine plus information on the accessories that can really help to enhance your free-motion experience.

To skip this section and go to our current selection of templates [click here](#).

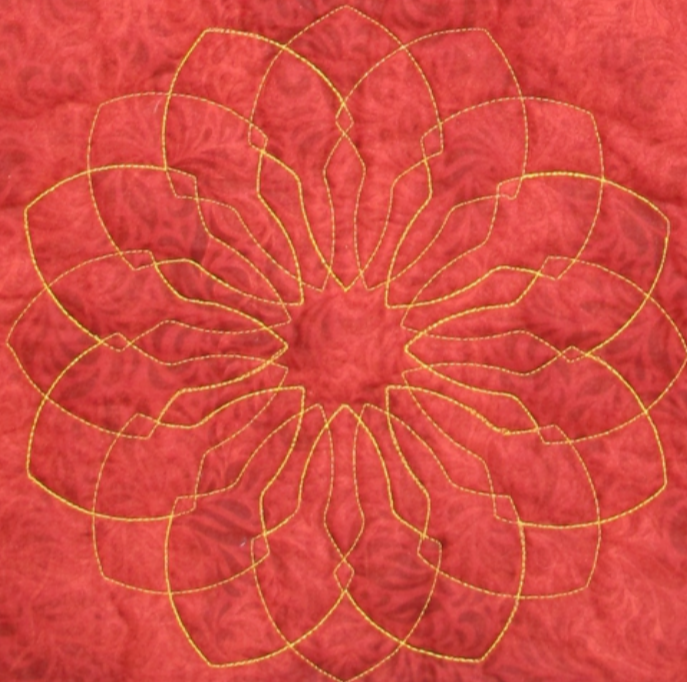
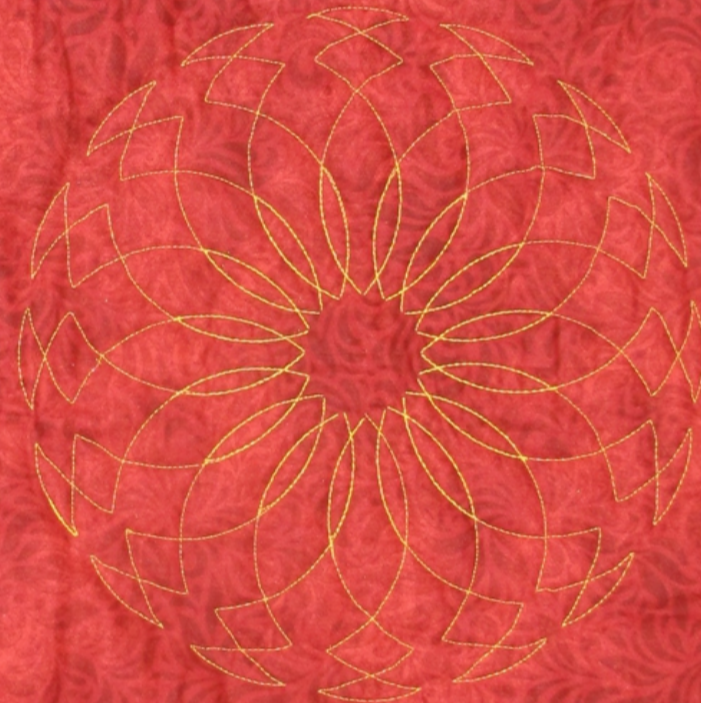
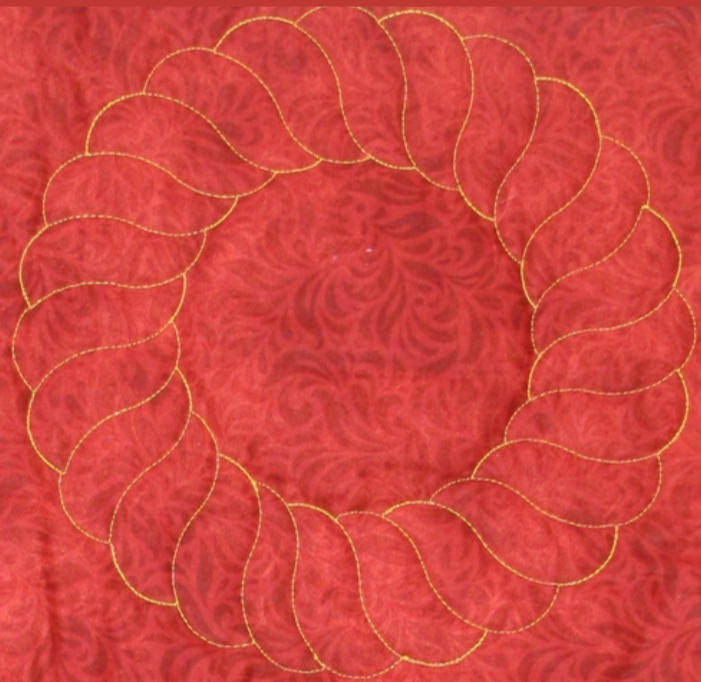

The Domestic Quilting Machine - What You Need To Consider

Small-arm machines are usually domestic sewing machines with a throat space of up to 12".

Not all sewing machines are ideal candidates for machine quilting. Some are for general sewing where others have been designed specifically with quilting in mind. Below are a list of features that are recommended for successful quilting on a domestic machine.



- 8"+ throat space. Yes, it is possible to quilt with less, but you will struggle to cope with the quilt bulk on anything smaller.
- A variable speed motor for greater control when free-motion quilting. The motor should be strong enough to not overheat with prolonged use.
- Needle-up and needle-down control. Having the ability to control where the needle lands is very important when using templates and rulers.
- Adjustable stitch length and the ability to stitch in reverse.
- An easy access and easy-to-wind bobbin.
- The Westalee Foot if you are using Westalee Rulers. Otherwise for general free-motion quilting an open toe darning or appliqué foot or an adjustable free-motion foot will give better stitching visibility. Feet that can be changed easily are a useful bonus if you need to switch between feet.
- The ability to drop or cover the feed dogs.
- An extension table to expand the surface area around the quilt so that the bulk of the quilt does not drag on the needle.

If your current machine does not have an extension table then we can have one made for you!

Quilting anything of size can be a problem if you don't have an extension table. Gravity will pull the weight of your quilt down and cause it to drag, creating friction, which prevents good stitches from forming. Having a larger area of the quilt at the same level as the needle will give you control and help prevent drag.

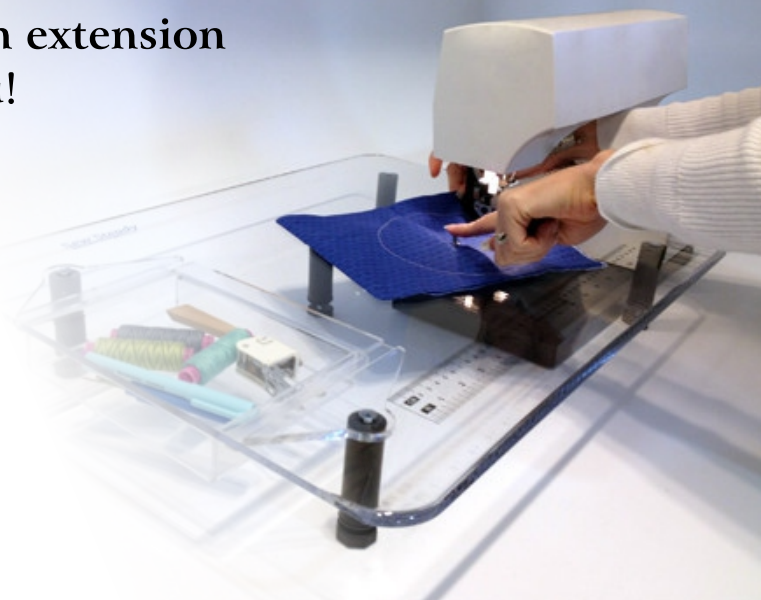

Dream World Northwest
Sew Steady
Made in the U.S.A.

The Sew Steady Portable Table is a clear Perspex top that can be cut to fit most sewing machines. The table surface is positioned flush with the free arm to create a larger work area.

As well as the benefits described above it creates a two-level surface so that items such as scissors, pins, etc can be kept easily to hand and can be seen through the clear perspex table. Available in three sizes.

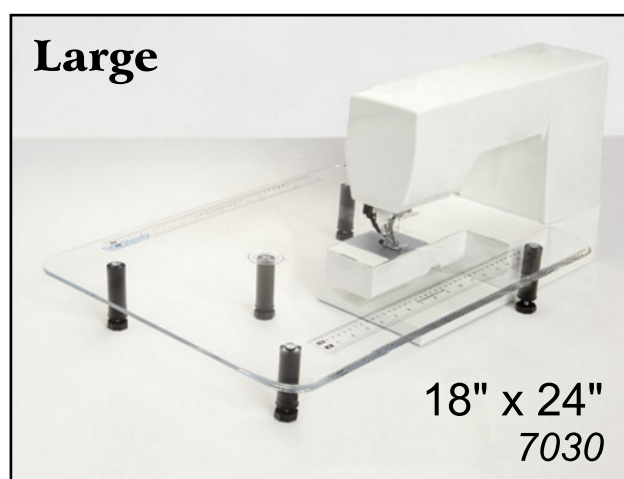
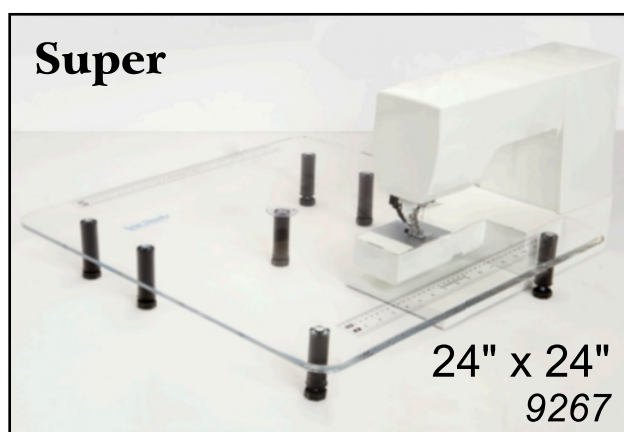

Please note, the acrylic table is cut to fit snugly around each model of sewing machine so it is not interchangeable between different models.

With so many sewing machines on the market these tables have to be made to order. We will require the make and model of your machine. Please allow six to eight weeks for delivery.

Can be made to fit most domestic machines.

Perfect for classes - simply remove the feet to store flat.

Junior

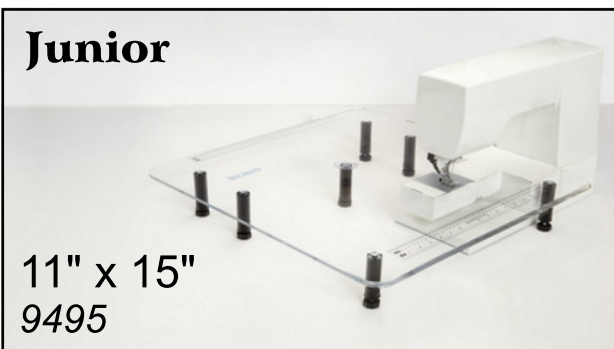

11" x 15"
9495

Please make sure you have the make and model number of your machine when you order your Sew Steady Table



19-Oct-15

Brilliant investment. I have been considering getting this extension table (7030) for some time, but was worried it wasn't worth the investment. How wrong I was. It has transformed the way I work. It has made working so much easier, reduced the tension in my shoulders and results in neater, straighter lines. It fits perfectly.

Petra - Welwyn Garden City

Sew Steady Table Angled

At 18" x 24" this table is the same size as the "large", but the cut-out for the free arm is set at an angle. This takes the body of the machine away from your right hand, giving you more space in which to manipulate your project.

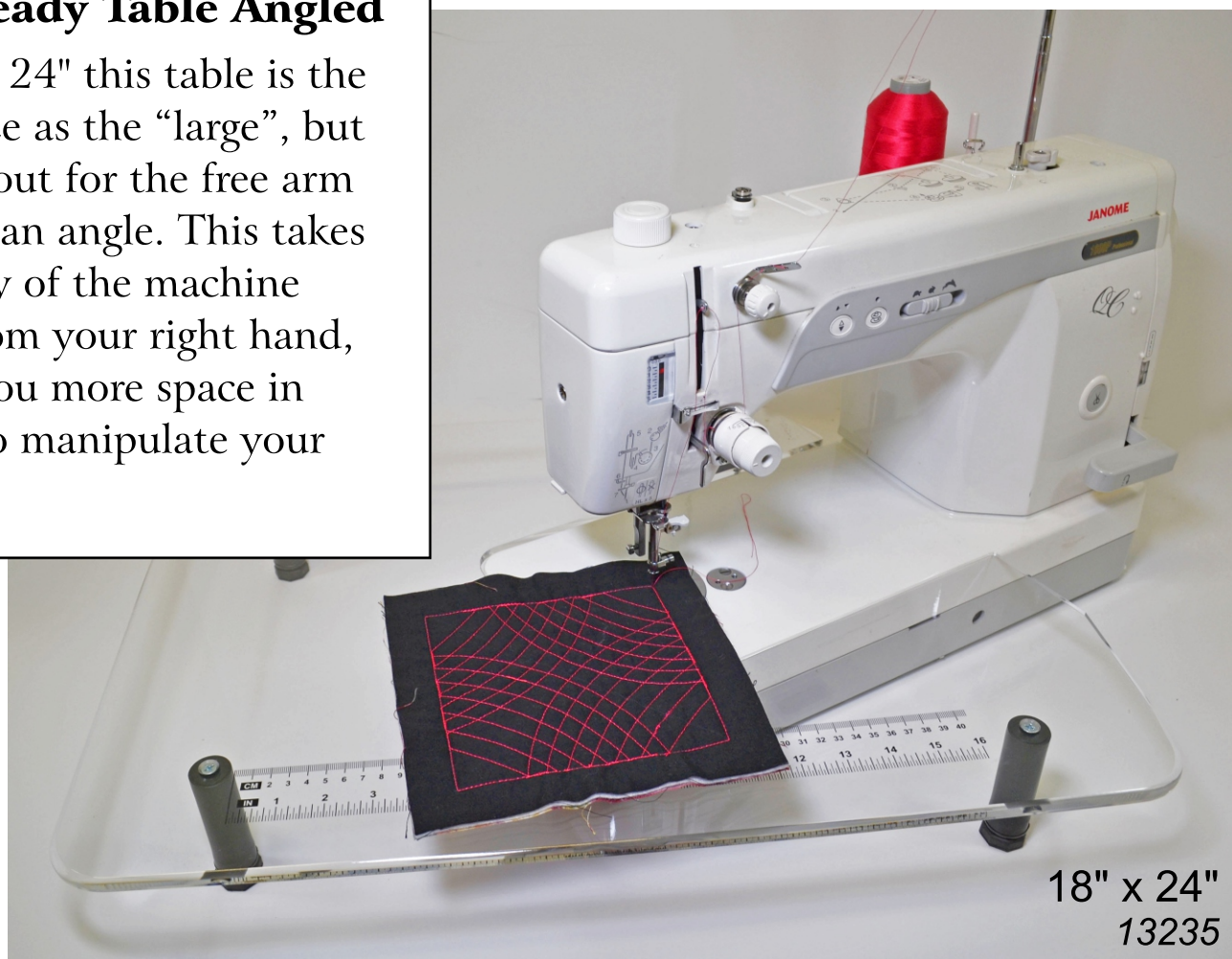

18" x 24"
13235

Click here to buy a Sew Steady table at www.cottonpatch.co.uk

Sew Steady Table Accessories

Universal Table & Insert Grid

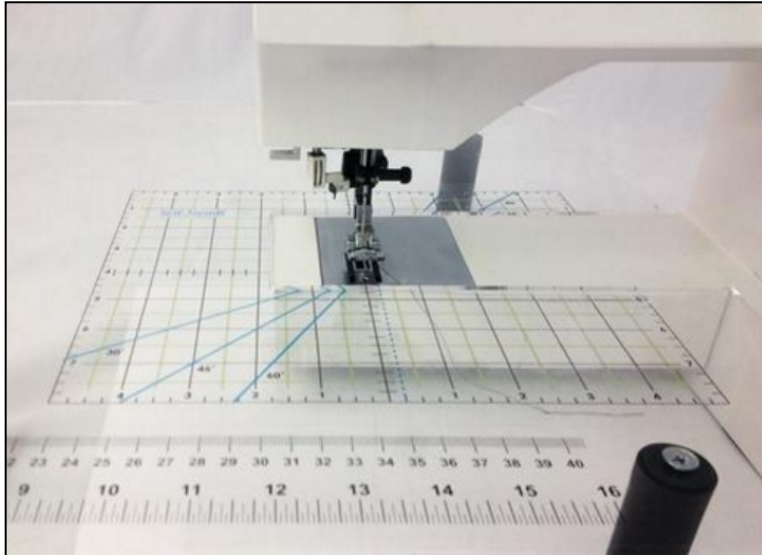

This Universal Grid attaches to the underside of any Sew Steady Portable Table or Cabinet Insert, and provides additional ruler guidance around the free arm. Grid measures 8" x 10", with imperial measurements plus angles. Includes Table Lock. *11630*



Spinner Tray

Store notions under your Sew Steady Table and spin out with ease using this acrylic spinner tray (left).

Designed to attach to any Sew Steady Table leg. Includes a magnetic corner to corral pins and needles. 6" x 8" - excellent for small work spaces to keep sewing tools visible and easy to access. *11631*



Padded Carry Bag

A useful, protective, travel bag. Designed to hold a standard 18" x 24" Sew Steady Table, it will also store an 18" x 24" cutting mat and rulers. A padded pouch on the side holds the table legs or other accessories. *10356*



[Click here to purchase at www.cottonpatch.co.uk](http://www.cottonpatch.co.uk)

Sew Steady Table Accessories

Quilting around any ruler or template requires a flat surface for a perfect finish. Any bumps or dips have the potential to knock your stitching out of line and distort the shape. But many machines have these uneven surfaces: where the needle plate meets the casing or where the extension table meets the casing for example (right).

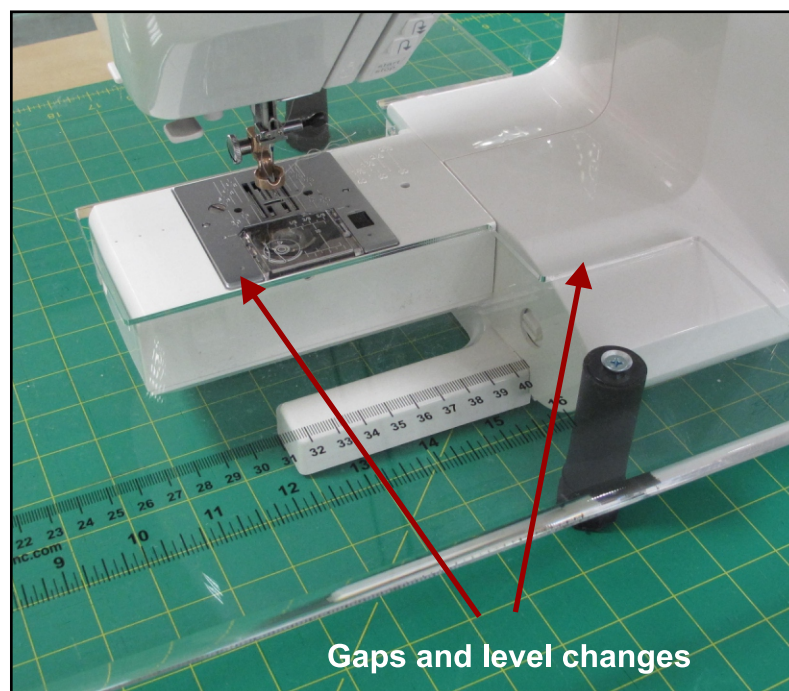

Free Motion Glider

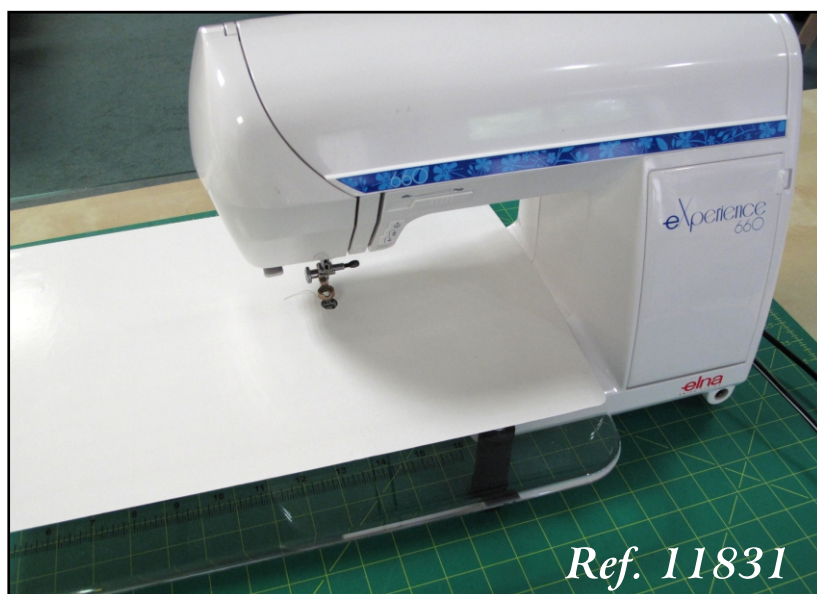

The **Free Motion Glider** is a white, 12" x 18" Teflon mat that is positioned over the machine and extension table and so removes any inconsistencies. A pre-cut hole is positioned below the needle to access the thread. The Teflon surface allows the quilt sandwich to move about easily as you quilt. The special tacky backing holds it firmly in place, but it peels off easily and rolls up for storing, leaving no residue. Highly recommended!

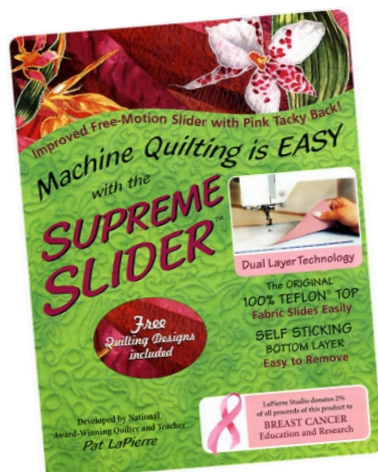

We also stock the **Supreme Slider**, a similar product, but in a smaller A4 size. It also has a pre-cut hole. Ref 9572

With either product you will need to attach a Westalee Ruler Foot or a free-motion or darning foot appropriate for your machine and lower the feed dogs.

[Click here to purchase at www.cottonpatch.co.uk](http://www.cottonpatch.co.uk)

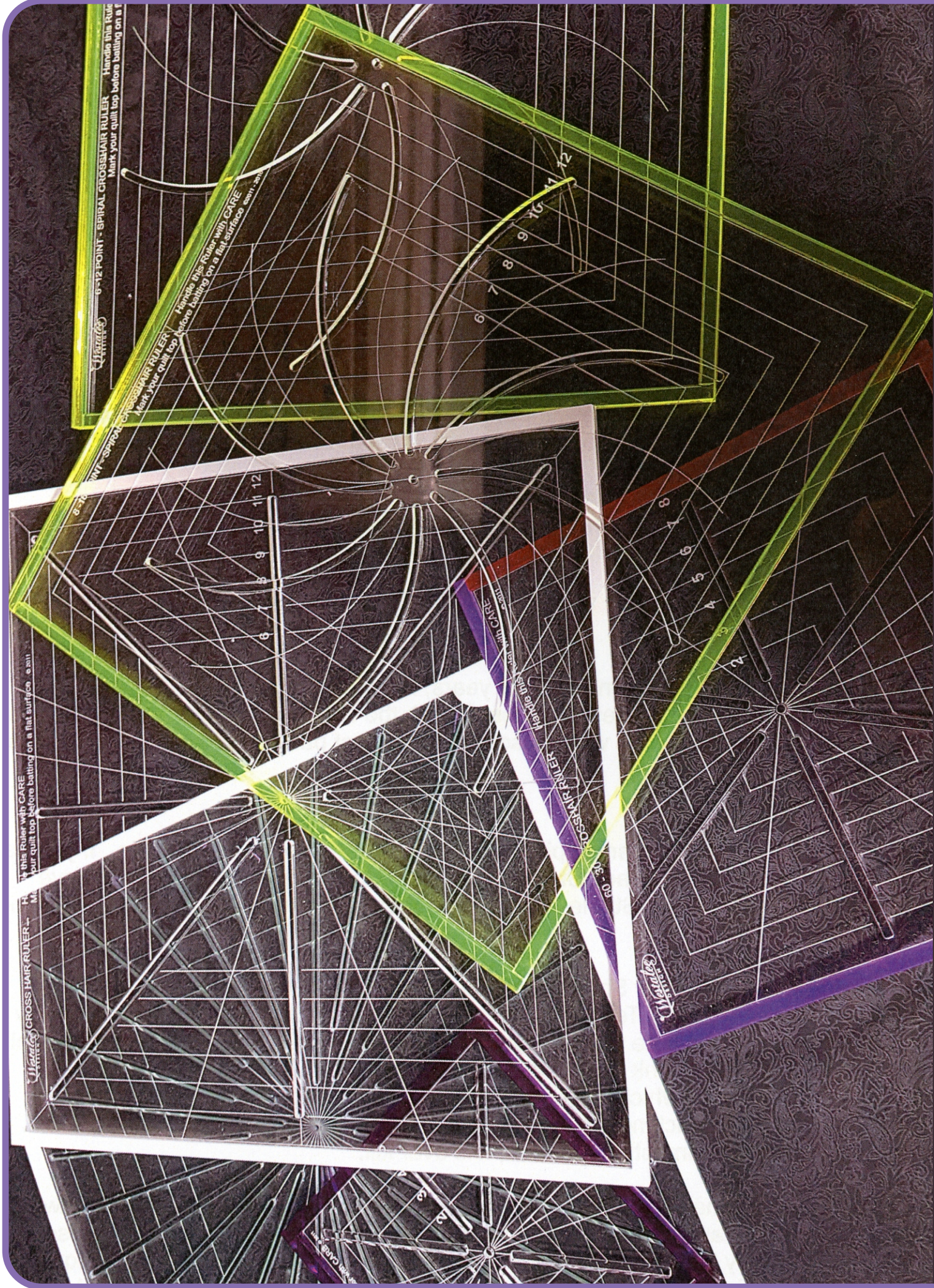

CROSSHAIR RULERS



The key to creating a rotational design such as the one shown on the left is accuracy - if your end point does not match up with the start point it's not going to look so impressive. There is more movement of the quilt sandwich on a domestic machine compared to a longarm machine so for larger or more complex rotating templates it can be harder to get an accurate result just by using the guidelines printed on the template.

The solution is to pre-mark the lines on the block using a Crosshair Square so you can be confident your design will complete a 360° rotation accurately.

There are five styles of 12½” square Crosshair Squares:

8 Point for marking 8, 16 and 32 reference lines. *11809*

6 Point for marking 6, 12 and 24 reference lines. *12920*

5 Point for marking 5, 10 and 20 reference lines. *12921*

8 Point Spiral for marking 8 and 16 reference lines. *13039*

6 Point Spiral for marking 6 and 12 reference lines. *13038*

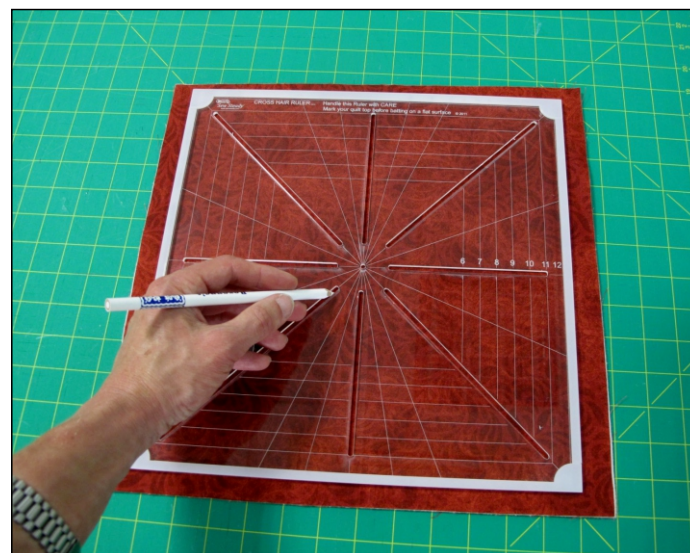

Small Crosshair Squares

The three most popular Crosshairs are also available in an 8½” size which is more convenient if you are working on smaller blocks or for travelling to class etc.

8 Point (8, 16 and 32 lines). *13200*

6 Point (6, 12 and 24 lines). *13201*

5 Point (5, 10 and 20 lines). *13202*

[Click here to purchase at www.cottonpatch.co.uk](http://www.cottonpatch.co.uk)

All the examples on this page were made with just one template (Spin-e-fex No.12)

The 5 Point Crosshair with
5 (top), 10 and 20 rotations

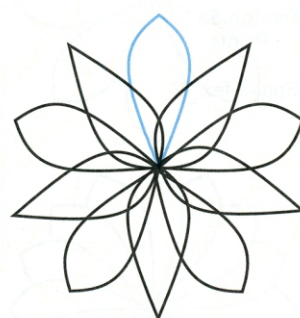
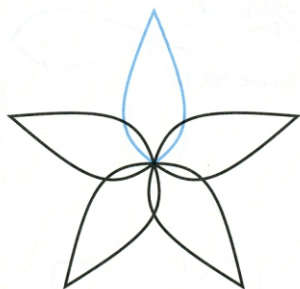

The 6 Point Crosshair with
6 (top), 12 and 24 rotations

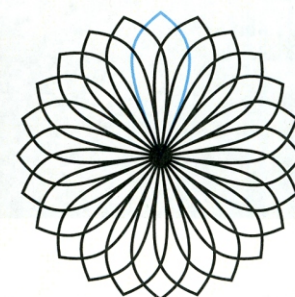
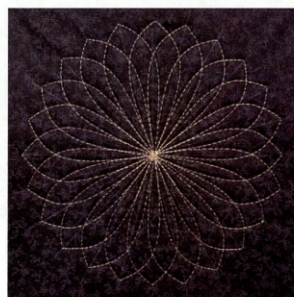
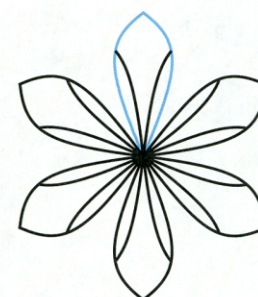
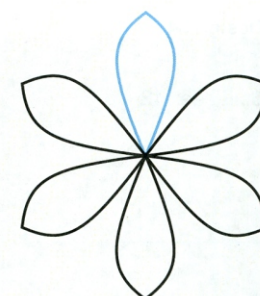

The 8 Point Crosshair with 4, 8, 16 and 32 rotations

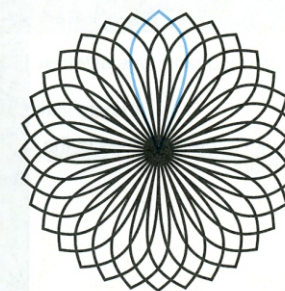
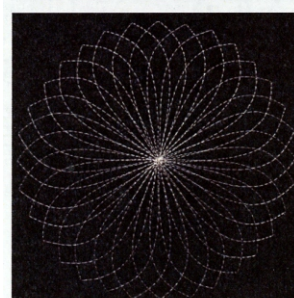
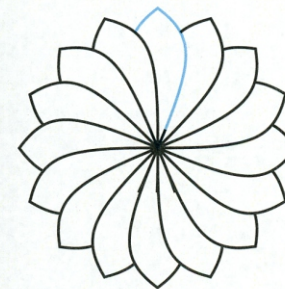
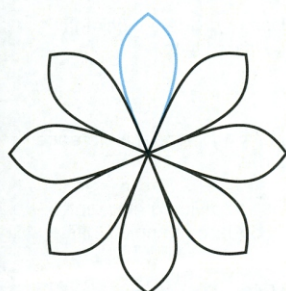
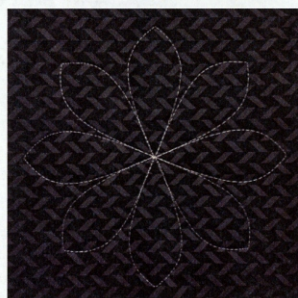
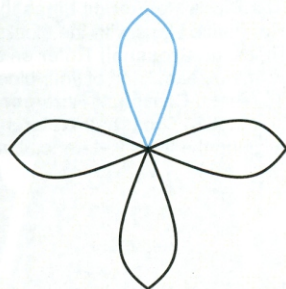
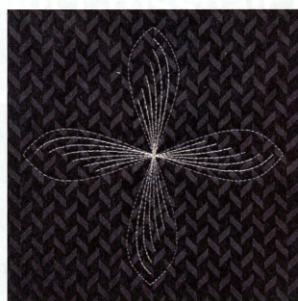

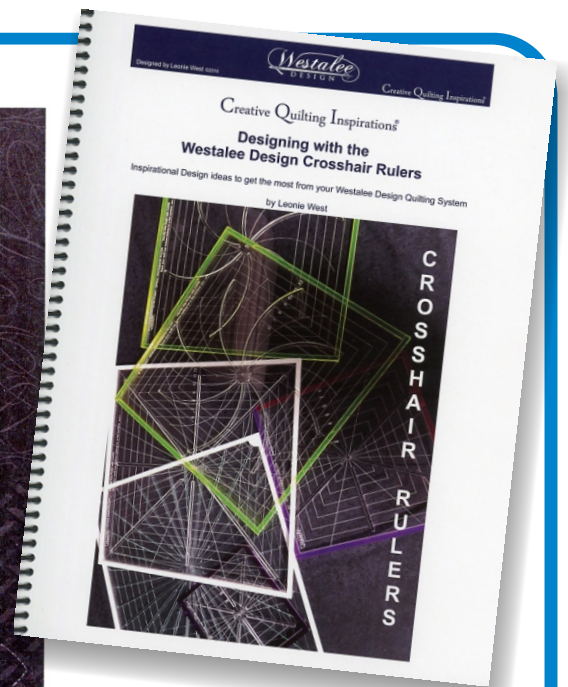
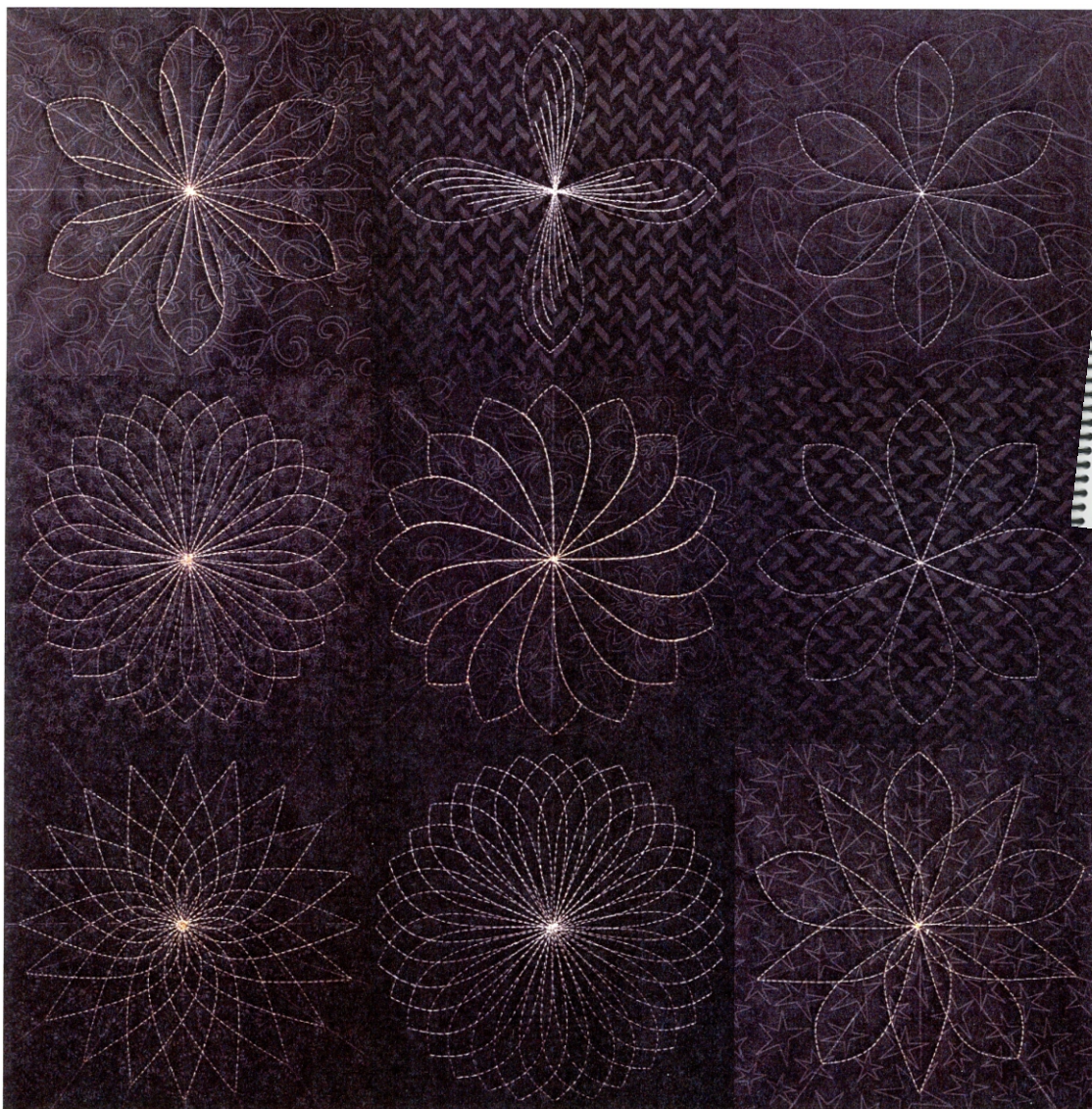

Designing with the Westalee Design Crosshair Rulers
by Leonie West
Spiralbound, 58 pages. 13082

This sampler is constructed from the examples on the previous page. It demonstrates how much variety you can achieve using just a single rotating template in combination with the different Crosshair Squares.

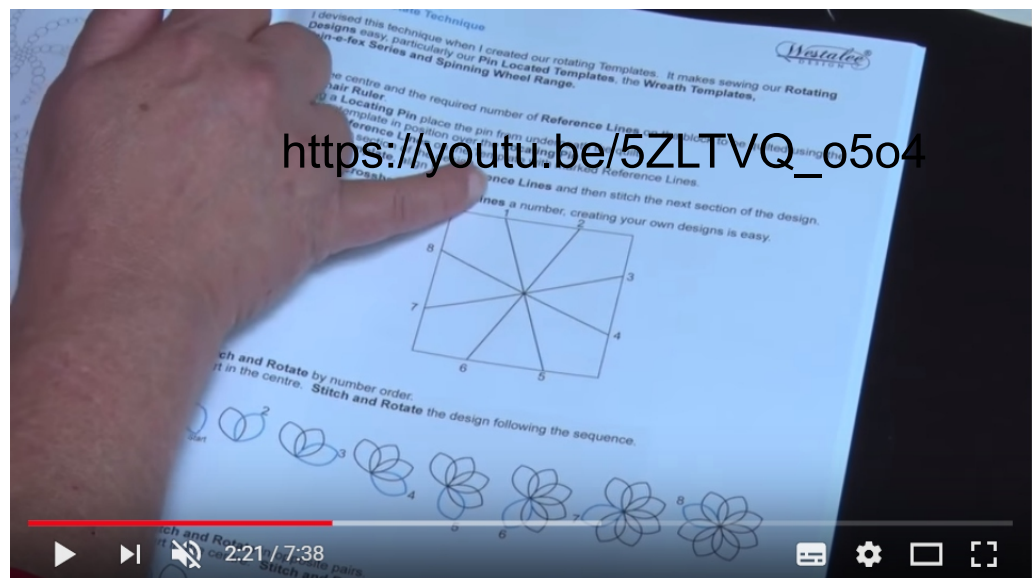

Click on the video to find out more about what you can achieve with Crosshair rulers.

Click here to purchase at www.cottonpatch.co.uk

Spiral Crosshair Rulers

The Spiral Crosshair rulers are also 12½" x 12½" and are available as either 6/12 point rotation (right) or 8/16 point rotation (far right).

These Crosshairs are used differently to the straight line Crosshairs - you can use smaller templates such as the Simple Circles or Mini Spin-e-Fex and build up designs along the line of the curves as shown in these examples.

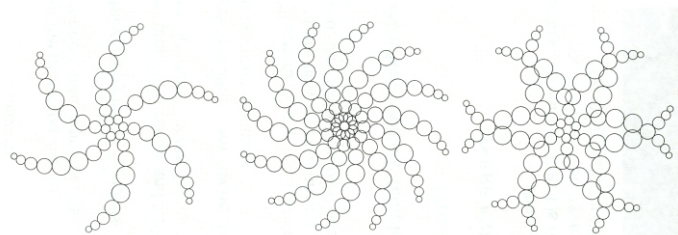
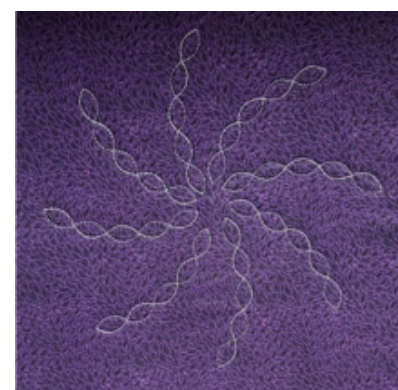
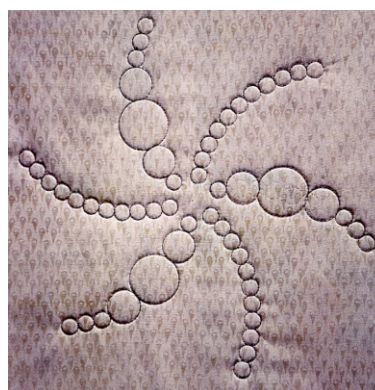
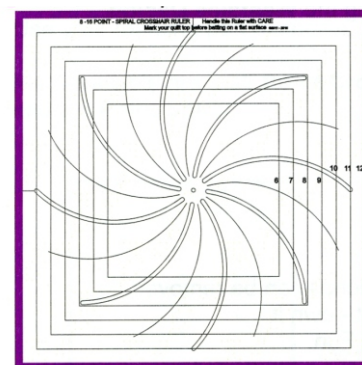
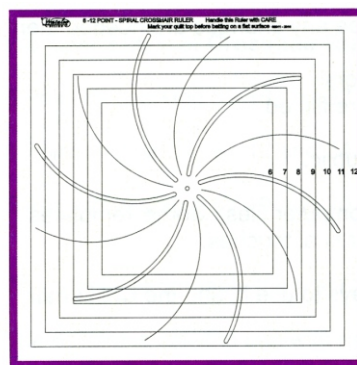

Below are some examples of templates that can be used in conjunction with the Spiral Crosshair Rulers:

Simple Circles



A set of 4 circle templates that allow you to quilt circles. Sew circles in ½", 1", 1½" and 2" diameters.

Mini Spin-e-Fex



A set of 3 mini Spin-e-Fex templates for creating 1½" or 2½" radius designs.

Between the Lines



A small circle template that is ideal for filling spaces between lines. Available in ½" or 1".

Westalee Block Design Kit

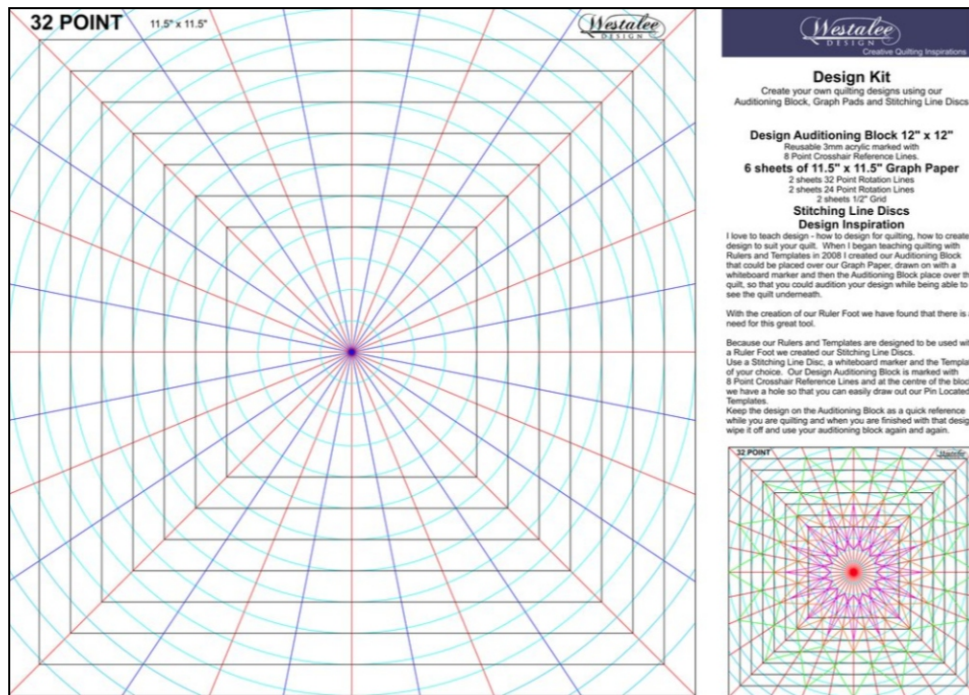

Create your own quilting designs. Kit includes:

12" x 12" Design Auditioning Block. 3mm acrylic marked with 8 point crosshair reference lines.

6 sheets of 11" x 11" Graph Paper (2 sheets with 32 point rotation lines, 2 sheets with 24 point rotation lines and 2 sheets with a 1/2" grid).

Stitching Line Discs

When Leonie began teaching with rulers and templates she used an “auditioning block”, an acrylic sheet to show how a design would look in a quilt without stitching it out. Placing the acrylic over graph paper, she would draw out the design onto the acrylic using a whiteboard marker. The acrylic was then placed on top of the quilt to see how it would look on the actual fabric.

This Design Kit follows the same principle: place the graph paper that suits your design the best under the acrylic (the 1/2" grid is good for borders and sashing). Trace around your chosen template(s) onto the acrylic block using the Stitching Line Discs (these discs add a 1/4" to mimic the Ruler Foot). The acrylic has a hole in the middle so you can use the pin location system for rotating templates. Audition your block on your quilt and if you are happy with it keep it as a reference while you are quilting then wipe it clean for your next block.

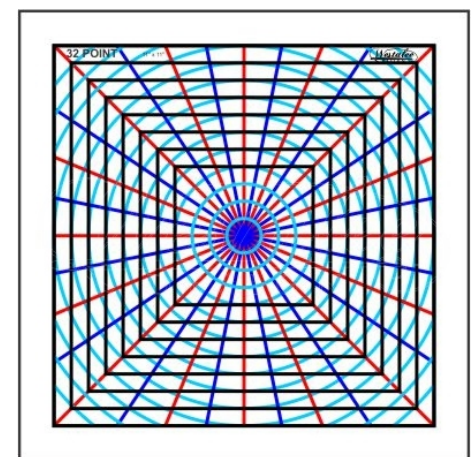

32 Point Graph Paper

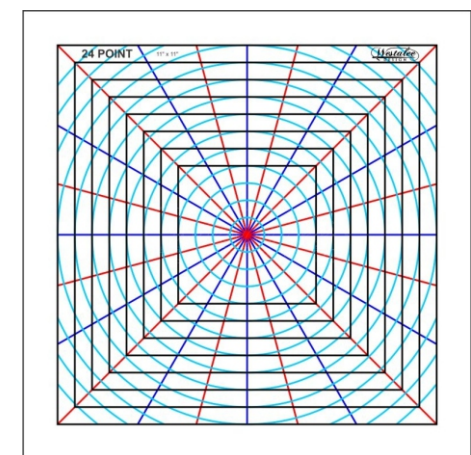

24 Point Graph Paper

[Click here to purchase at www.cottonpatch.co.uk](http://www.cottonpatch.co.uk)

ACCESSORIES

Little Rotation Bobs

Two handy little tools for marking evenly spaced rotations when using templates such as the Spin-e-fex.

One has slots for 16 rotations and the other has 12 rotations. 9cm diameter. *12131*

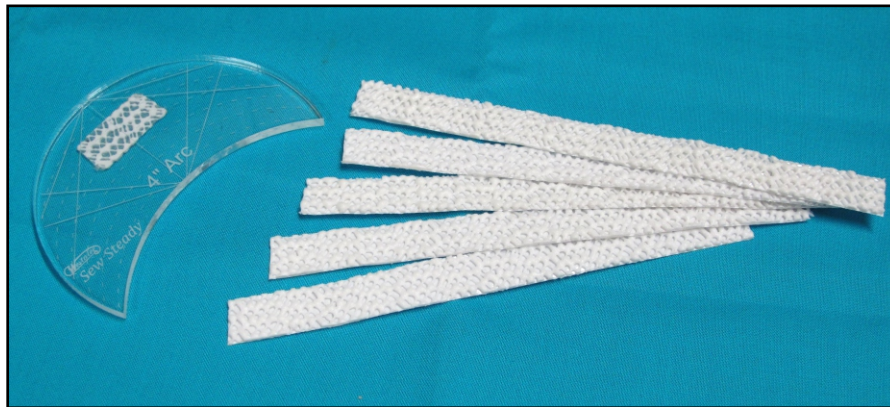
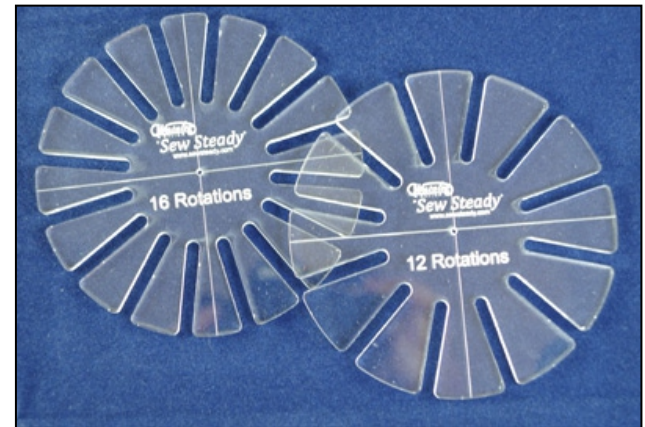

Stable Tape

The Ruler Foot Starter Set comes with a strip of Stable Tape included. If you need more to apply to your other templates it is available in packs of 5 strips (*11828*) or 12 strips (*13161*).

Spacing Gauge

This handy little gadget allows you to check your stitching distances and ruler position as you quilt. With 1/8", 1/4", 1/2" and 1" spacing. *11829*

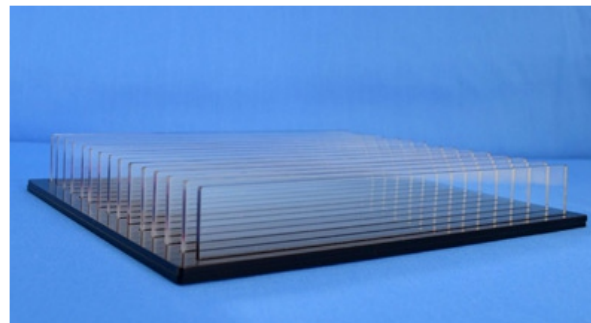

Ruler Rack

Keep your Westalee rulers tidy and to hand with this smart, 14 slot ruler rack.



The Rack comes with a coloured acrylic base and clear dividers (rulers are not included). *12693*

[Click here to purchase at www.cottonpatch.co.uk](http://www.cottonpatch.co.uk)

Stitching Line Discs

Use these small ½ inch diameter circles to trace an accurate ¼ line along the edge of a ruler or template to simulate the stitching line. A very handy gadget that allows you to experiment with designs and fine-tune the positioning before putting them into a quilt

Made from clear cast acrylic. 8 in a pack with 4 different hole sizes to suit your choice of marking tool. *12122*

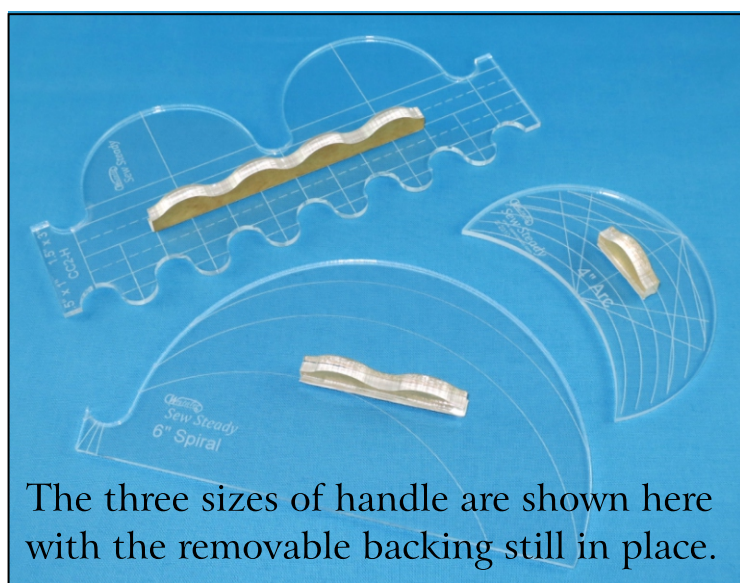
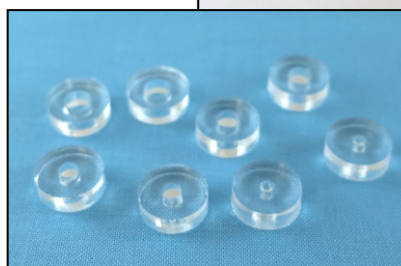
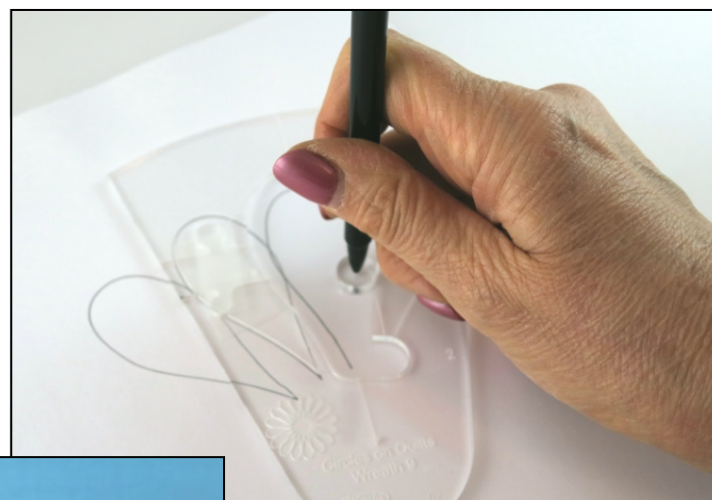

The three sizes of handle are shown here with the removable backing still in place.

Add A Handle

Add these peel-and-stick handles to your rulers and templates for a more side-to-side control and stability. They're just the right height to grip between two fingers or rest fingers over or alongside them, without being so tall that rulers become hard to store. Each pack contains 2 long, 2 medium, and two small handles. Clear acrylic with removable film on the sides. *12129*

Echo Guides

Echo a design with these great little guides that come in 3 sizes. ½", 3/4" and 1" sizes. For a demonstration of how to use these watch the video on the right. *11830*



<https://youtu.be/4FTDak4AMDc>

Click here to purchase at www.cottonpatch.co.uk

Machingers Gloves

Successful free-motion quilting is all about controlling the movement of the quilt sandwich. No quilter should be without these fabulous gloves that improve not just free-motion quilting, but handling fabric in general.

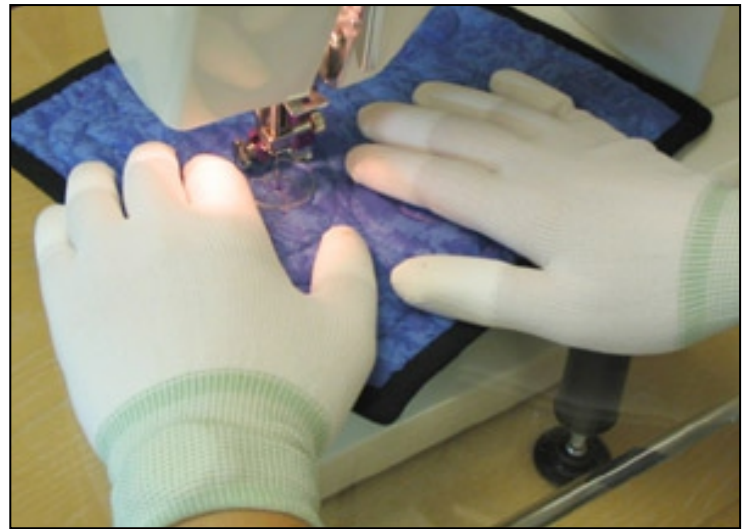

- Fully coated fingertips for excellent grip with less resistance and drag on fabric. No coating on palm allows skin to breathe in cool comfort.
- Made of nylon knit in the style of a true support glove, comfortable enough to wear for hours. And because they're nylon, threads don't stick.
- Seamless design gives freedom to use fingertips or full hand surface for quilting.

Because they are lightweight and form-fitting you can keep the gloves on to pull up bobbin thread, thread needle, clip threads, adjust fabrics, and add or remove pins. Available in 4 sizes.



With all the many factors to consider your choice of wadding might not be your immediate concern. However, the type of wadding you use does play a big part in the appearance of your quilting. If you would like to learn more about wadding click on the image to open our Wadding ebook.

If you just want a recommendation then we would suggest Quilters Dream Green. Made from recycled plastic bottles, it is very consistent with enough loft to show off your stitches nicely without being too bulky.

[Click here to buy Machingers at www.cottonpatch.co.uk](http://www.cottonpatch.co.uk)

There are many factors that contribute to successful machine quilting and one of them is thread tension. You may find this video useful if you are struggle to get the correct tension on your machine. Having a good quality, strong thread is also essential.

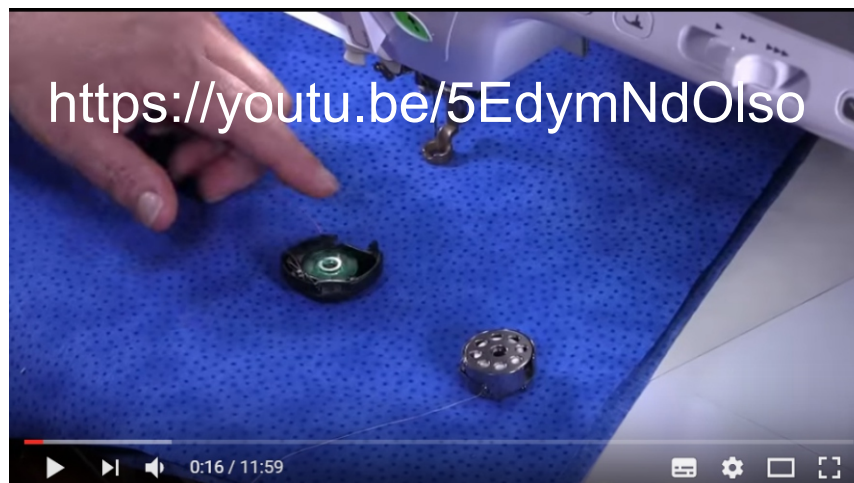

The most popular choice for machine quilting

Have You Tried Glide?

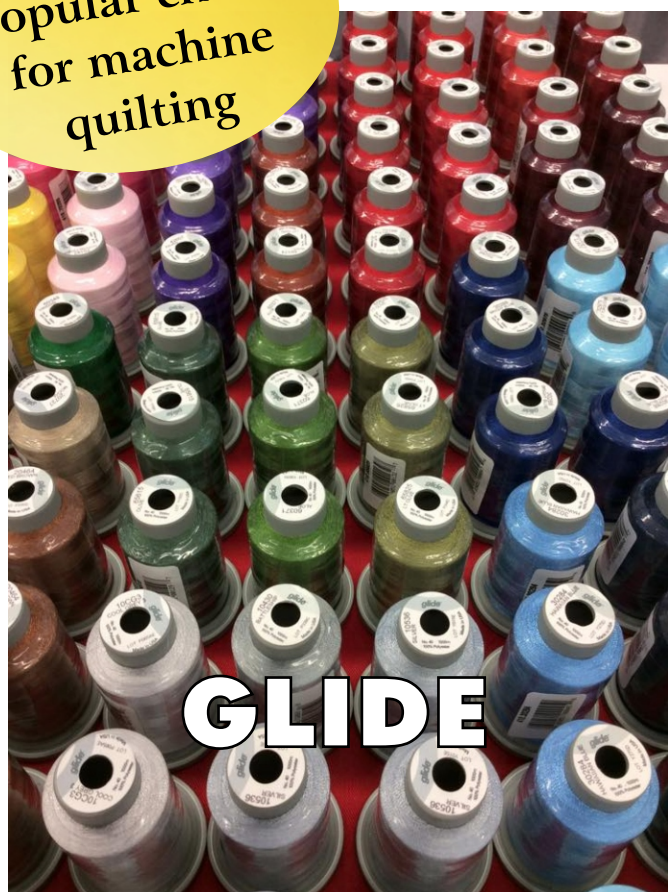

Glide is a relatively new thread that has made a big impression, becoming the thread of choice for quilt artists (and just look at the reviews on our website!).

Glide is a 40wt polyester thread with “Advanced Trilobal Technology”. It maintains consistent tension throughout each and every spool. The results are high quality, consistent stitch formation, fewer thread breaks, and fewer machine stops.

We have over 200 colours to choose from and the 1000m spools mean you don't have to worry about running out of thread. At just £3.95 per spool they are excellent value.



If you have a big project in mind the selected colours of Glide are available on 5000m King cones. We also stock a finer 60wt thread - great choice for small letter embroidery, micro-stippling and fine-detail quilting. It also is very good in the bobbin.



Click here to buy Glide at www.cottonpatch.co.uk

Glide Boxed Set with free Super Satchel Thread Box

Our selection of 30 Glide threads on 1000m spools includes a rainbow of colours plus popular neutral tones. They come displayed in a sturdy Super Satchel Box worth £15.95 at no charge. 12577

We also have Glide in over 60 colours on 5000m spools.



06-Oct-16



1000m - £3.95
5000m - £12.95

Lovely thread. Glide was recommended to me by a friend who quilts with a long arm and I liked the colours she showed me, so I gave it a try, although I work on a domestic machine, not a long arm. I find it absolutely beautiful, it makes a lovely stitch and runs really well through my machine.

anonymous



Double Cone Thread Holder

If your domestic machine can't handle large sized cones then this Double Cone Thread Holder adapts large size cones for use on standard sewing machines. Holds 2 cones ready for quick sewing. Suitable for all types of cone threads. 9025

Topstitch Needles

Start your quilting project with a new needle! These topstitch needles are extra sharp with a longer eye and deeper groove than the standard size 100 Universal needle. Good for topstitching and decorative work without making large holes in the fabric. Can be used with metallic threads.

Schmetz Topstitch:
5 needles in sizes 80/12, 90/14 or 100/16.



[Click here to buy the Cone Holder](#) and [here to buy Needles](#)

Piecing Quilted Blocks Together

One of the challenges for the domestic machine quilter is working with the restriction of a smaller free arm. One solution to this is to complete your blocks and quilting in sections and then assemble the blocks.

Leonie has devised a technique for sashing quilted blocks together using the Westalee Ruler Foot and a **Lineworks SashLeeQuilt** template.



This sashing technique can be used to great effect as shown in the quilt section above (see next page for the full quilt design). Depending on your fabric choice the sashing can be chosen to complement or contrast with the block colours. You can find out more about the technique in the video below.

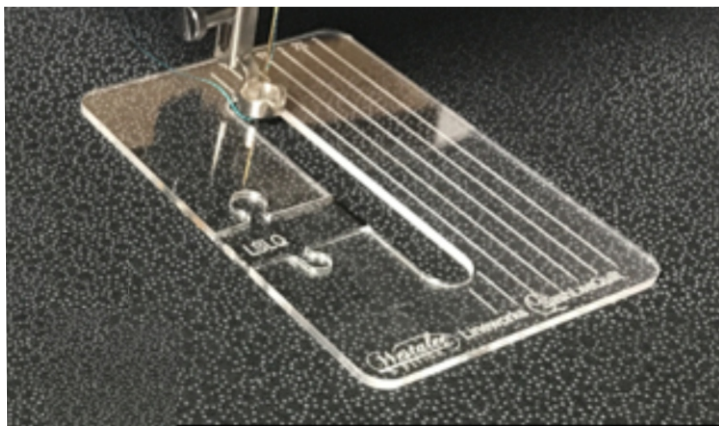

The technique can be used for any size block or border. An instruction booklet is included with the template that covers creating 1", 1½", 2", 2½" and 3" wide sashing. Available in Low (12824) and High Shank (12825).



[Click here to purchase HIGH Shank](#) or [here for LOW Shank](#)

Quilt Class in a Bag: Continuum



There's a touch of Nouveau, Deco and Contemporary design in this stylish Continuum quilt designed by Leonie. This *quilt class in a bag* contains all the templates you need to create the block designs featured in the quilt. A project guide is included plus a DVD in which Leonie explains how to stitch

out the designs and construct the quilt in sections. Please note that the Westalee Ruler Foot is *not* included. Leonie's sample quilt above measures 87" x 78". The inset picture shows another example of the quilt created by Janet Collins.



Leonie's sample quilt uses four different grey prints and a contrasting teal thread. Fabric not included - you have complete freedom in your fabric and thread choice.

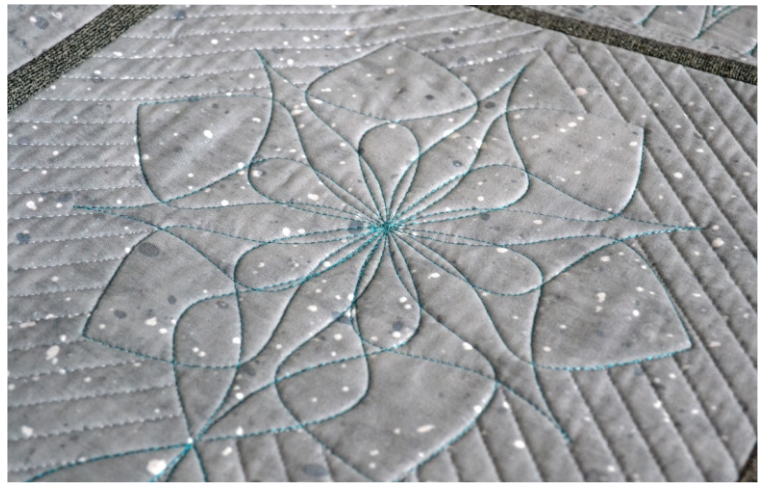

Quilt Class in a Bag: Continuum



- Contents are packed in a smart Yazzii bag:
- 6 Point (30° - 60°) 8 1/2" Crosshair Square
- Spin-e-fex 11 - 9 1/2" Template
- Hearts-a-Plenty 4 Template 2" x 4"
- SashLeeQuilt Template
- Continuous Border Loop 2" x 2"
- Spacing Gauge
- Stable Tape
- Instructional DVD and Book

Available in **Low Shank (13029)** or **High Shank (13030)**

[Click here to purchase HIGH Shank](#) or [here for LOW Shank](#)

Feather Template Set

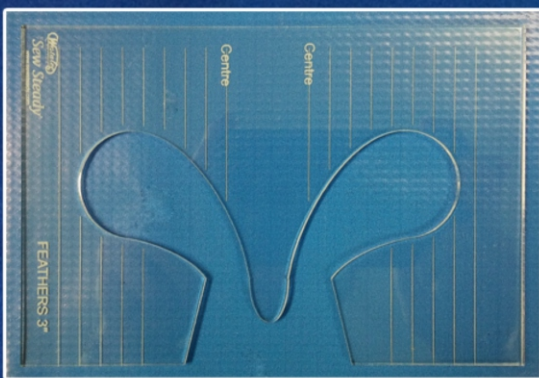
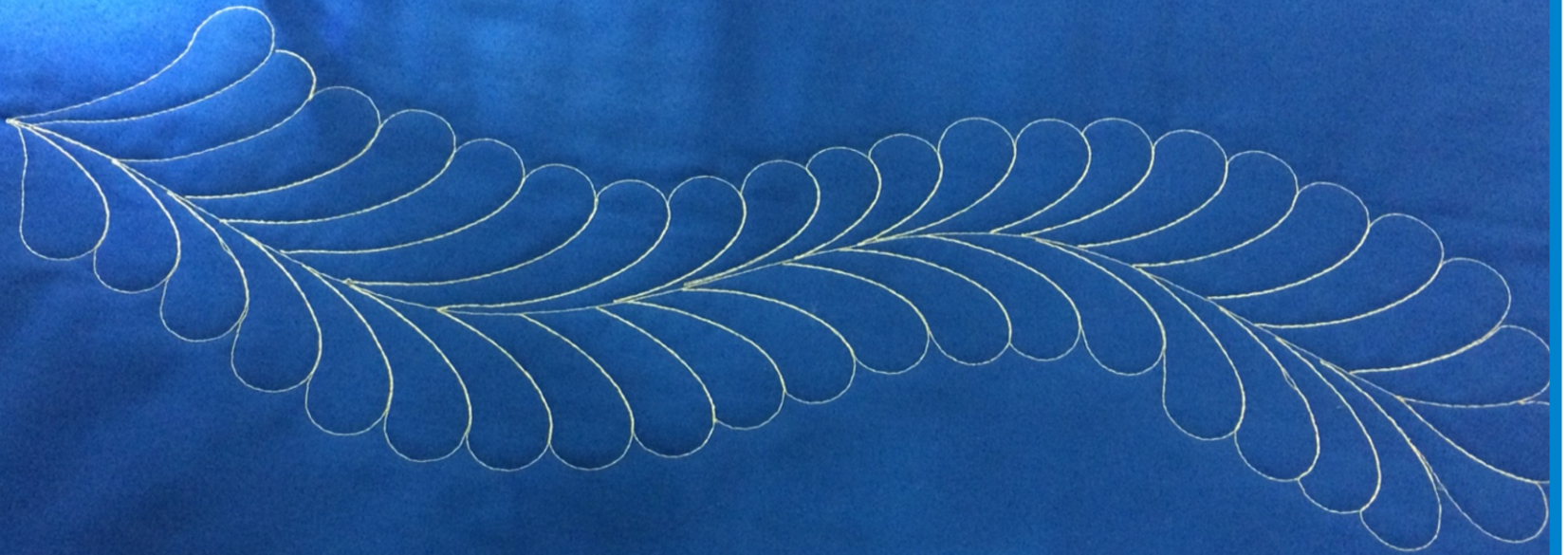

Quilting feathers can be difficult, but with the Feather Templates you can quilt straight feathers, feathers on a wavy spine or feathered plumes.

Feathers

Available in 2", 3", 4" and 5"

Westalee
DESIGN
Sew Steady®

General Instructions

Stitch 2 lines to represent the border.

Stitch 1 line in the centre to create a centre point.

Place the Ruler Foot at the centre point (shown in blue)

Line up the centre-stitched line with the centre point on the template.

Stitch around one side of the template back to the centre point (shown in red)

Stitch around the opposite side of the template (watch the video on next page for more details).

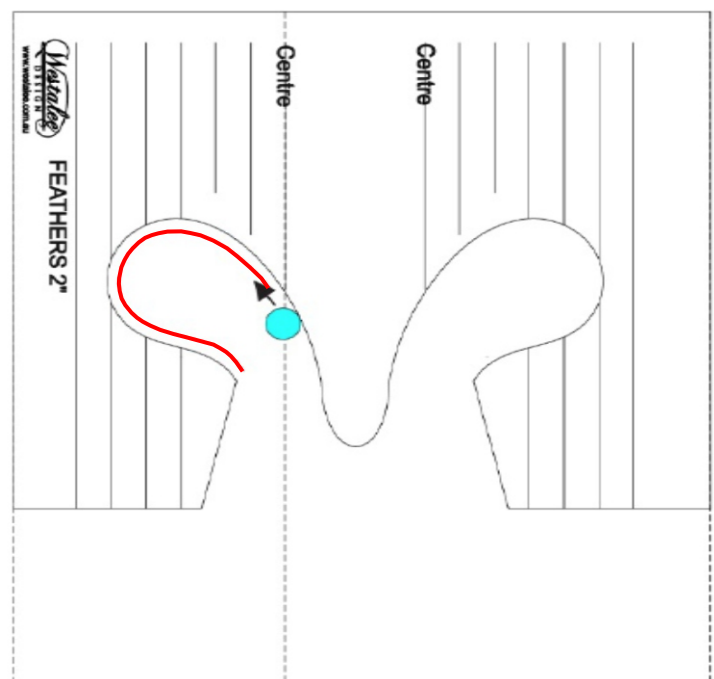

[Click here to purchase HIGH Shank](#) or [here for LOW Shank](#)

Feather templates can be purchased individually or as a set of four.

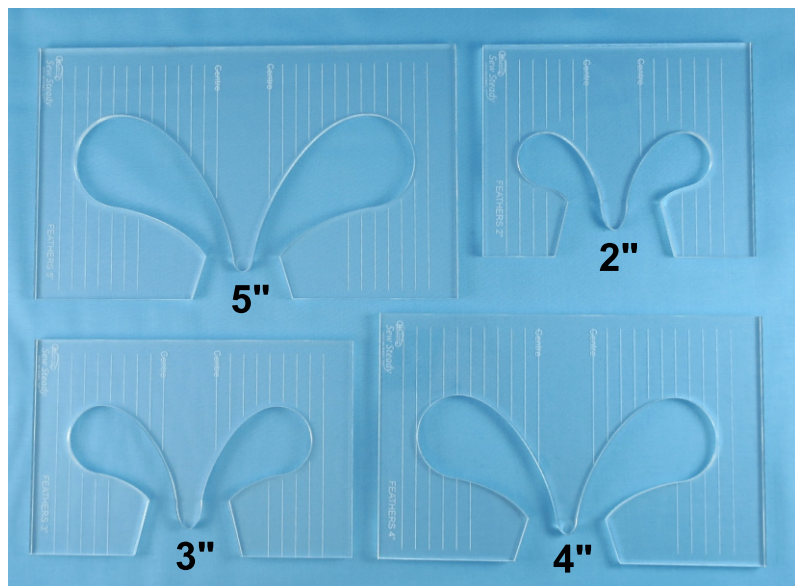

Stitch your feathers to a regular, repeating curve for your borders (example above) with a Feather Spine template. Choose from a 10" or 12" repeat.

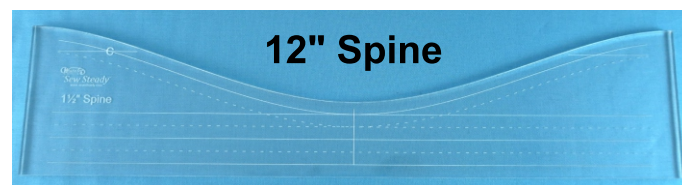
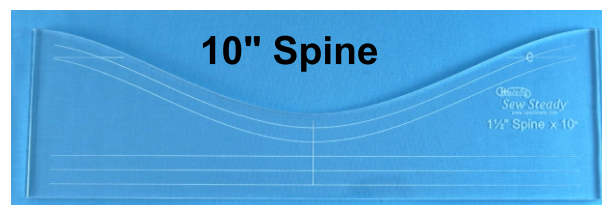

Leonie West explains how to create feathers using this template set



Simple Circles Sets

These circle sets allow you to create circles from 1/2" to 4" in diameter. Includes Stable Tape.

Set 1 contains four templates for sewing circles in 1/2", 1", 1 1/2" and 2" diameters.

Set 2 contains four templates for sewing circles in 2 1/2", 3", 3 1/2" and 4" diameters.

Note that the 2" diameter circle in **Simple Circle Set 1** is the same as the template in **Sampler Set 1**. Refer back to the Sampler Set page for the video on using this template.

All of the templates include a key gate so you can change templates without breaking thread or raising the foot.

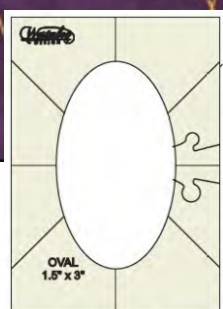
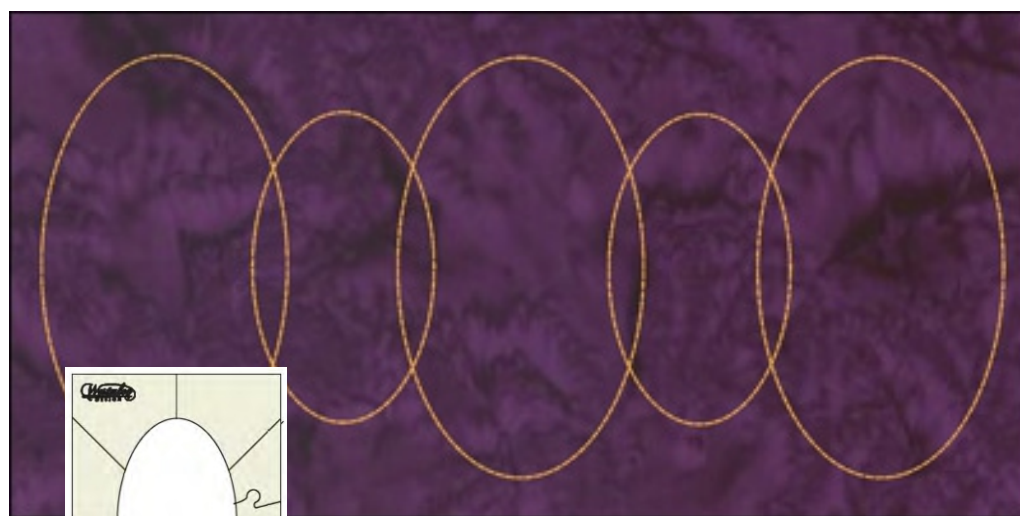
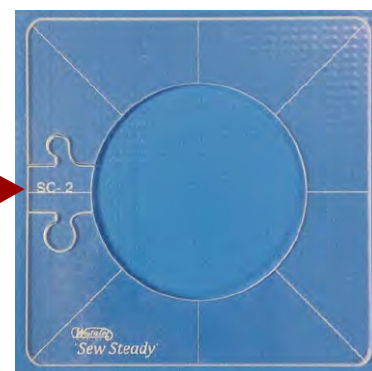

Simple Ovals Set

A three ruler set that allows you to quilt ovals. Sew ovals in 2" x 4", 1 1/2" x 3" and 1" x 2".

Includes Stable Tape.

All rulers have a Key Gate.

[Click here to purchase HIGH Shank](#) or [here for LOW Shank](#)



Arc Set

A set of five Arc templates that can be used to create a variety of designs that can stand alone or be used to offset and echo a specific design.

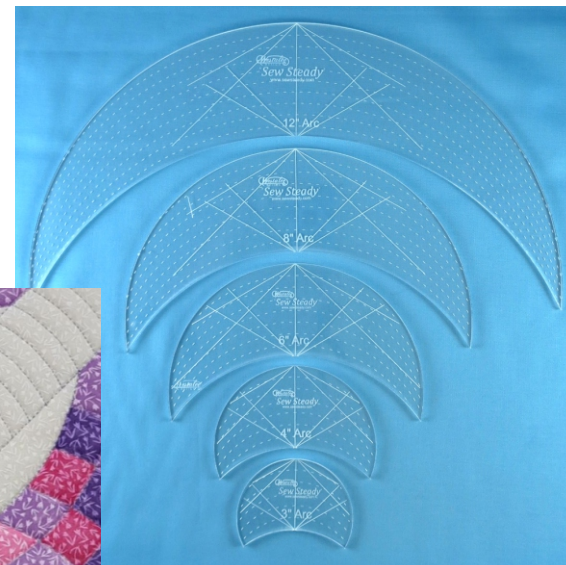

Arc sizes are 3", 4" (the 4" is also included in Sampler Set 1), 6", 8" and

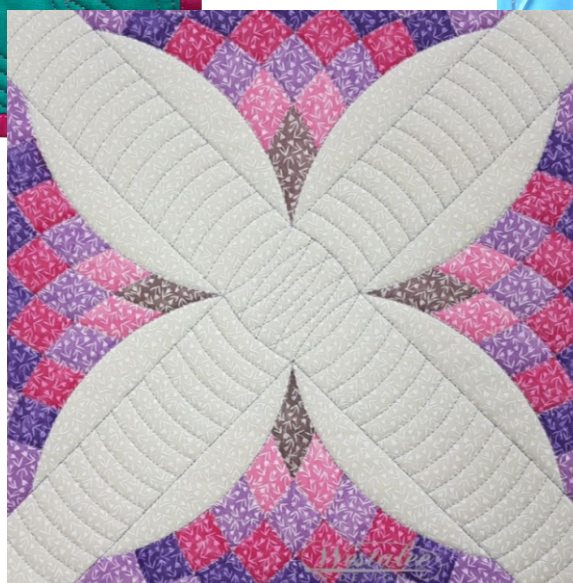

Hexagon Template Set

Create individual hexagons or continuous hexagon patterns in three sizes - 1", 1½" or 2". The size is the stitched distance across two parallel sides.

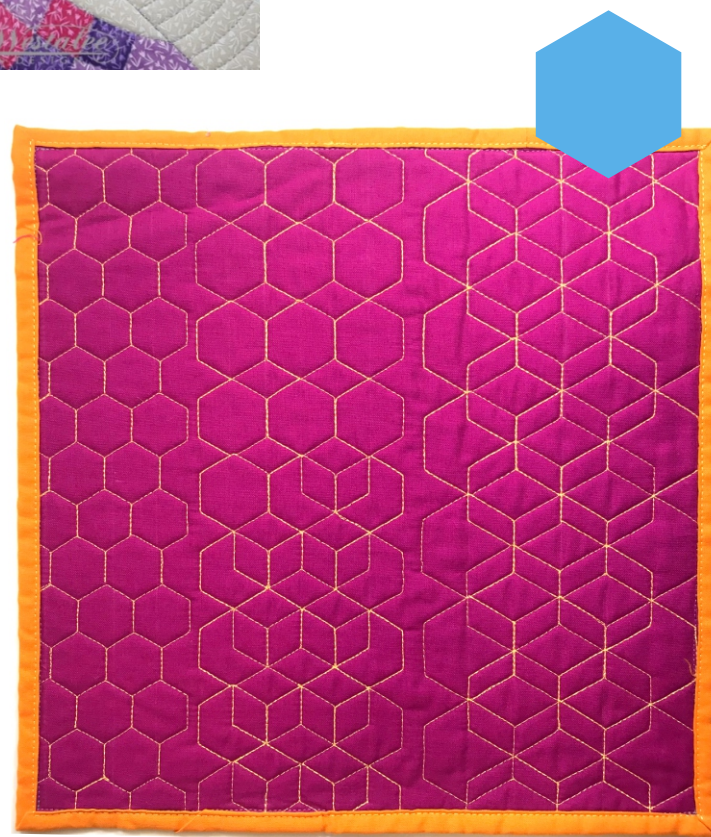
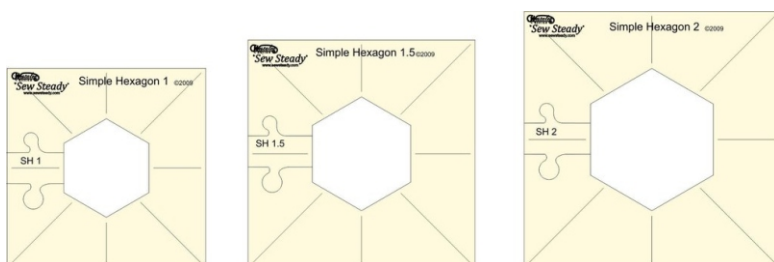

[Click here to purchase HIGH Shank](#) or [here for LOW Shank](#)

Circles on Quilts Templates

With Circles on Quilts you can sew concentric circles from 1" to 12". You can also use these templates to sew Baptist Fans and other designs.

The simple, single pin rotation for these templates make them super easy to position on your quilt.

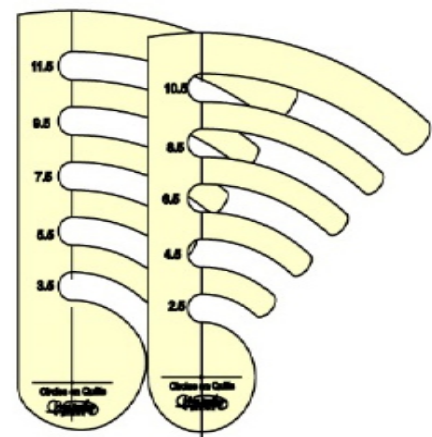

Circles On Quilts
Available in sets of 2 or 4

©Westalee Design 2013

Creating Circles Using a Pin

Circle templates are easy to use with the single pin provided in the set.

- 1) Find the centre of where you want to place your circle.
- 2) Insert the pin from under the quilt at the centre.
- 3) Place the template onto the pin with the pin through the hole.

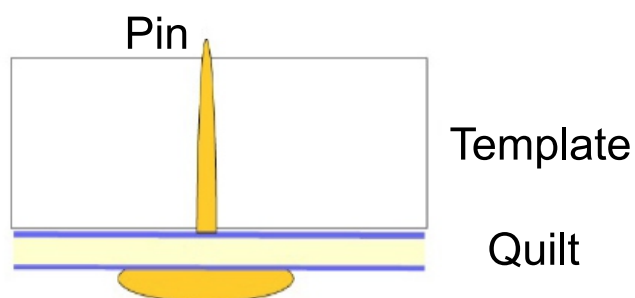

There two sets available (two templates per set). One set creates circles from 2" to 12" in one inch increments (one template does even inches, the other the odd inches).

The other set create circles from 2½" to 11½" again with one template for even inches and the other for odd inches.

Alternatively all for templates are available in a four set pack.



Leonie West shows how easy it is to create circles using these templates

Between the Lines Set

A four piece template set that enables you to stitch beautiful circles to create fill between lines. The set contains four templates for sewing circles in $\frac{1}{2}$ ", 1", $1\frac{1}{2}$ " and 2" diameters.

Please note that although the diameters for these circles are the same as in the Simple Circles Set 1, the etched lines on the template are different because the templates are used in a different way.



[Click here to purchase HIGH Shank](#) or [here for LOW Shank](#)

Miniature Baptist Fans

Use this set of four templates to create beautiful Baptist Fan fills. Used in combination, curves can be stitched with spacing as close as $\frac{1}{4}$ ", from $\frac{1}{4}$ " to $2\frac{1}{4}$ ".
Stitching out a design (right). More design options are shown below.

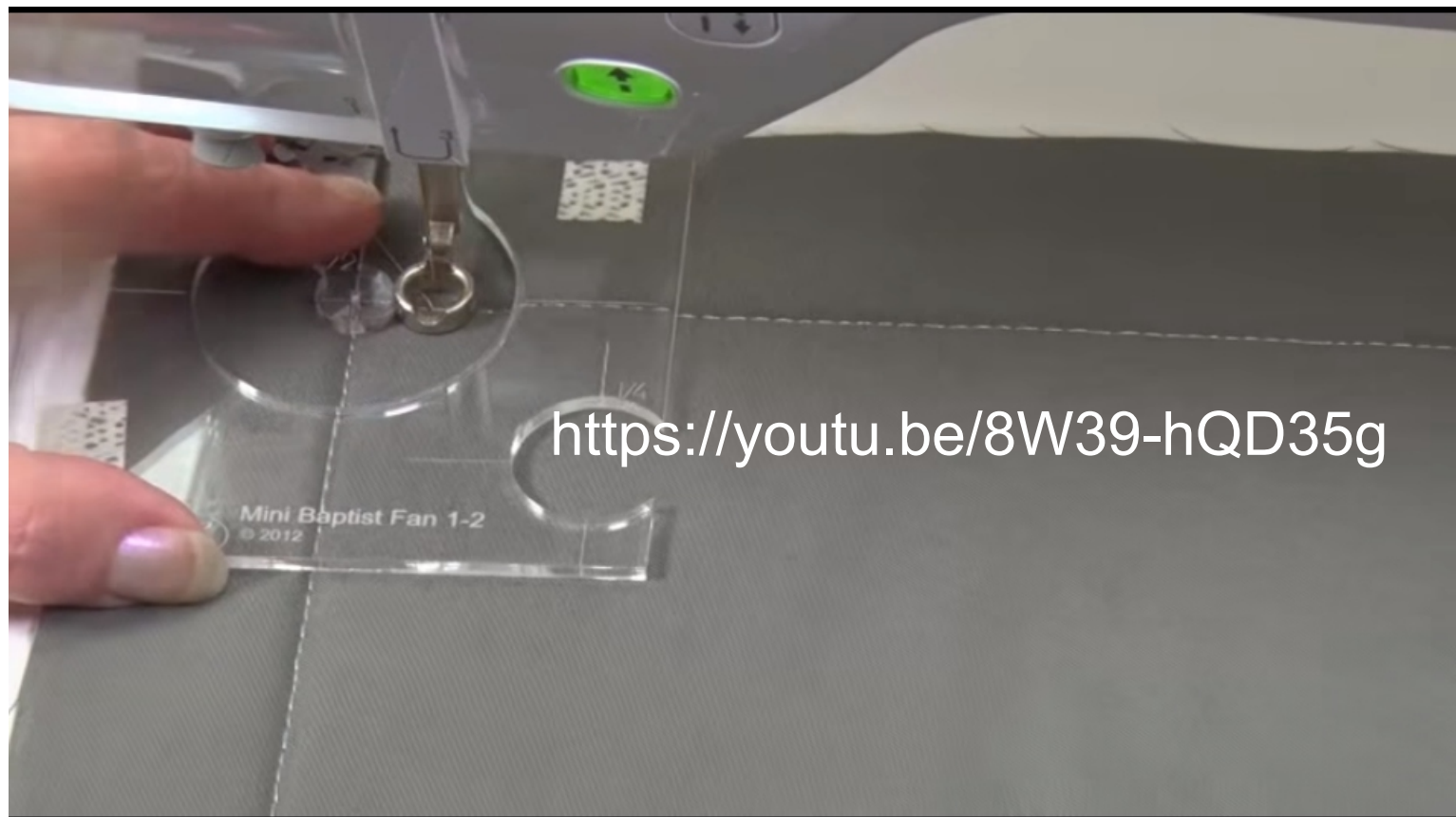
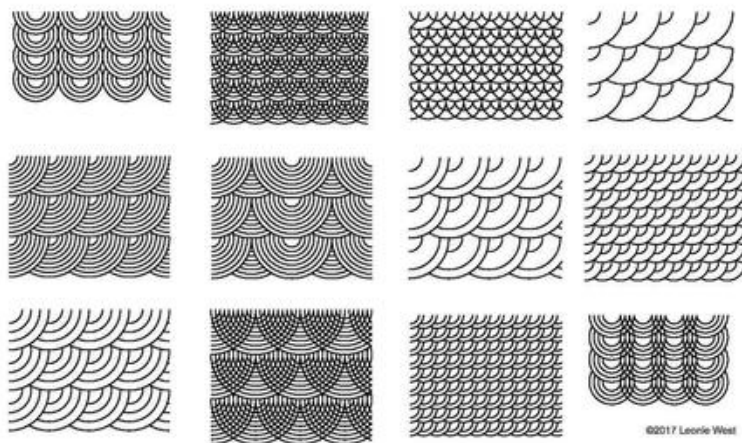

Leonie West demonstrates the Miniature Baptist Fan

[Click here to purchase HIGH Shank](#) or [here for LOW Shank](#)

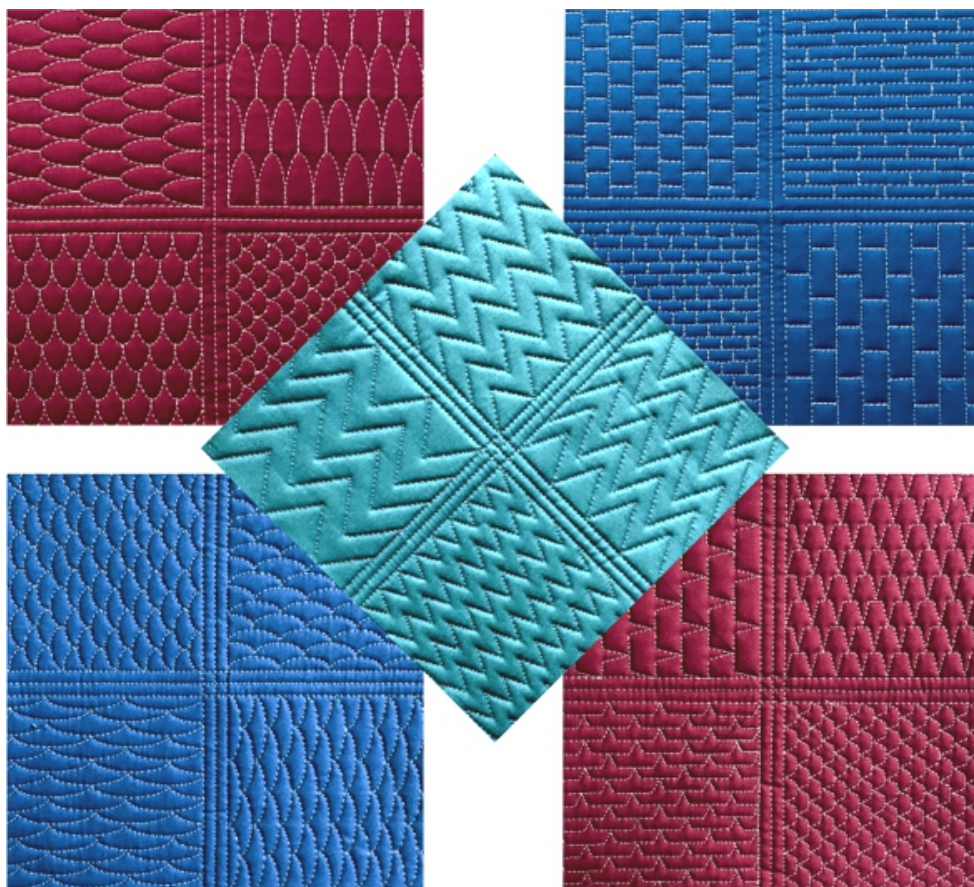

Mini Fills

These miniature designs are great for filling negative space or for miniature quilting.

The set contains 5 templates - zig zag, bricks, clamshells, tiles and clamshells no.2 (a squashed clamshell).

The video below explains how to use the zig zag template from the set.



Click here to purchase HIGH Shank or here for LOW Shank



Feathered Leaf: Circle Wreath

Quilt a stunning Circle of Feathered Leaves. Set includes 2 Templates – the Large Circle Wreath measures 11.5" at the outer edge of the Feathered Leaves – the Small Circle Wreath measures 5.5" at the outer edge of the Feathered leaves and fit perfectly inside the Large Circle Wreath.



This design is surprisingly easy to quilt, using the Westalee Design original Pin Location System.

Quilt with 1 Circle Wreath Line or 2 Circle Wreath Lines spaced 1" or 1/2" apart.



[Click here to purchase HIGH Shank](#) or [here for LOW Shank](#)

Feathered Leaf: Feathers and Finials

With this 5 piece set you can create graceful feather designs in 2", 3", 4" and 5" widths. The set includes a finials template that allows you to put a finishing feather in the centre or at the end of your design.

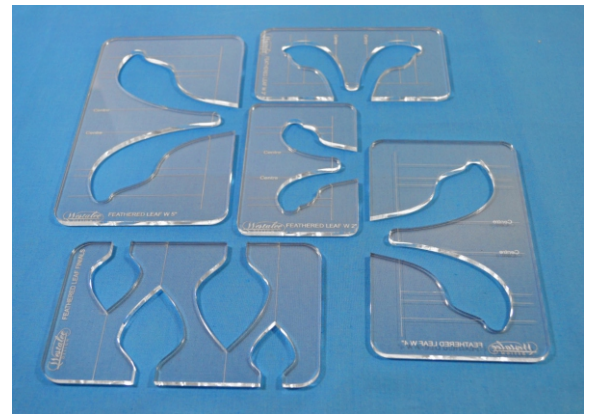

<https://youtu.be/hgdUWvIdG6o>

Leonie demonstrates how to use the Feathered Leaf template

Click here to purchase **HIGH Shank** or here for **LOW Shank**

The London Collection Flying Bell Curve Triangle

Inspired by a trip to London, Leonie has created this dynamic Flying Bell Curve Triangle template. There are five templates offering seven sizes: 6", 5", 4", 3" and a single, gateway template with three sizes 2", 1½" and 1".

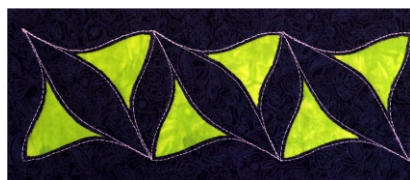
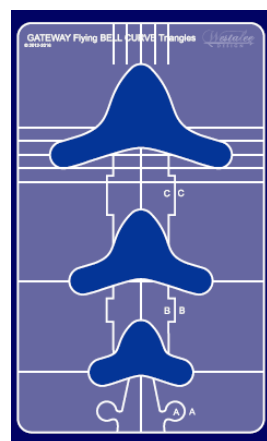
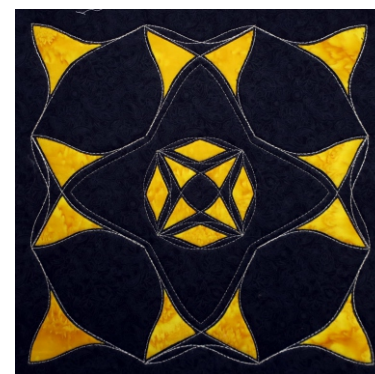
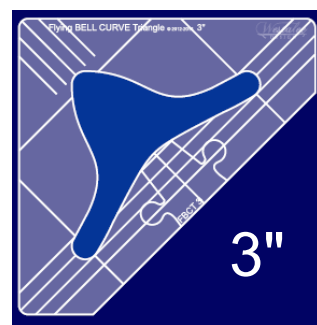
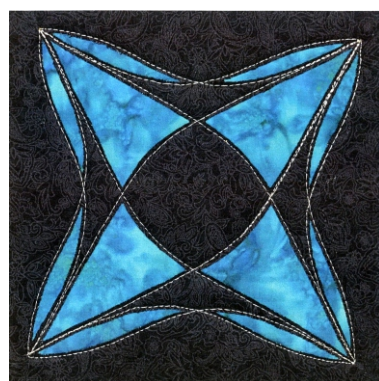
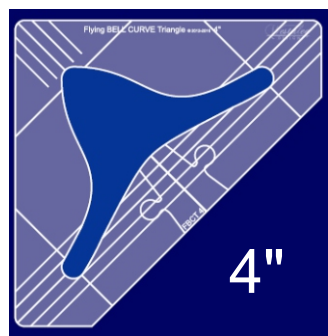
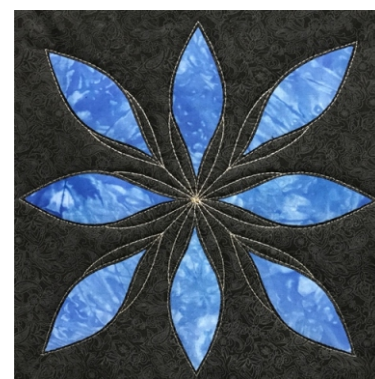
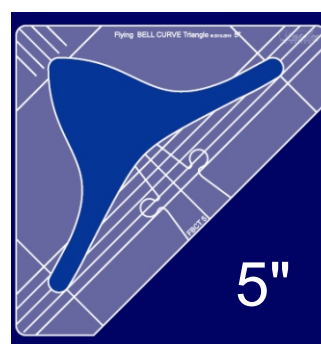
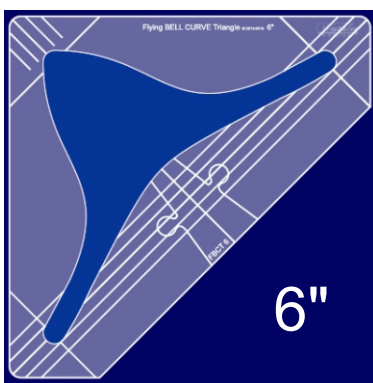

All five templates can be purchased individually or as a complete set.



2", 1.5", 1"

[Click here to purchase HIGH Shank](#) or [here for LOW Shank](#)

Leonie has written a Creative Quilting Inspiration booklet containing 12 quilting designs using the Flying Bell Curve templates.

It contains lots of diagrams, hints and tips and finished examples showing how to make the most of these templates.

The booklet is available as a free download from our website, [click here](#) to view.



You can also find out more about the templates in this video.

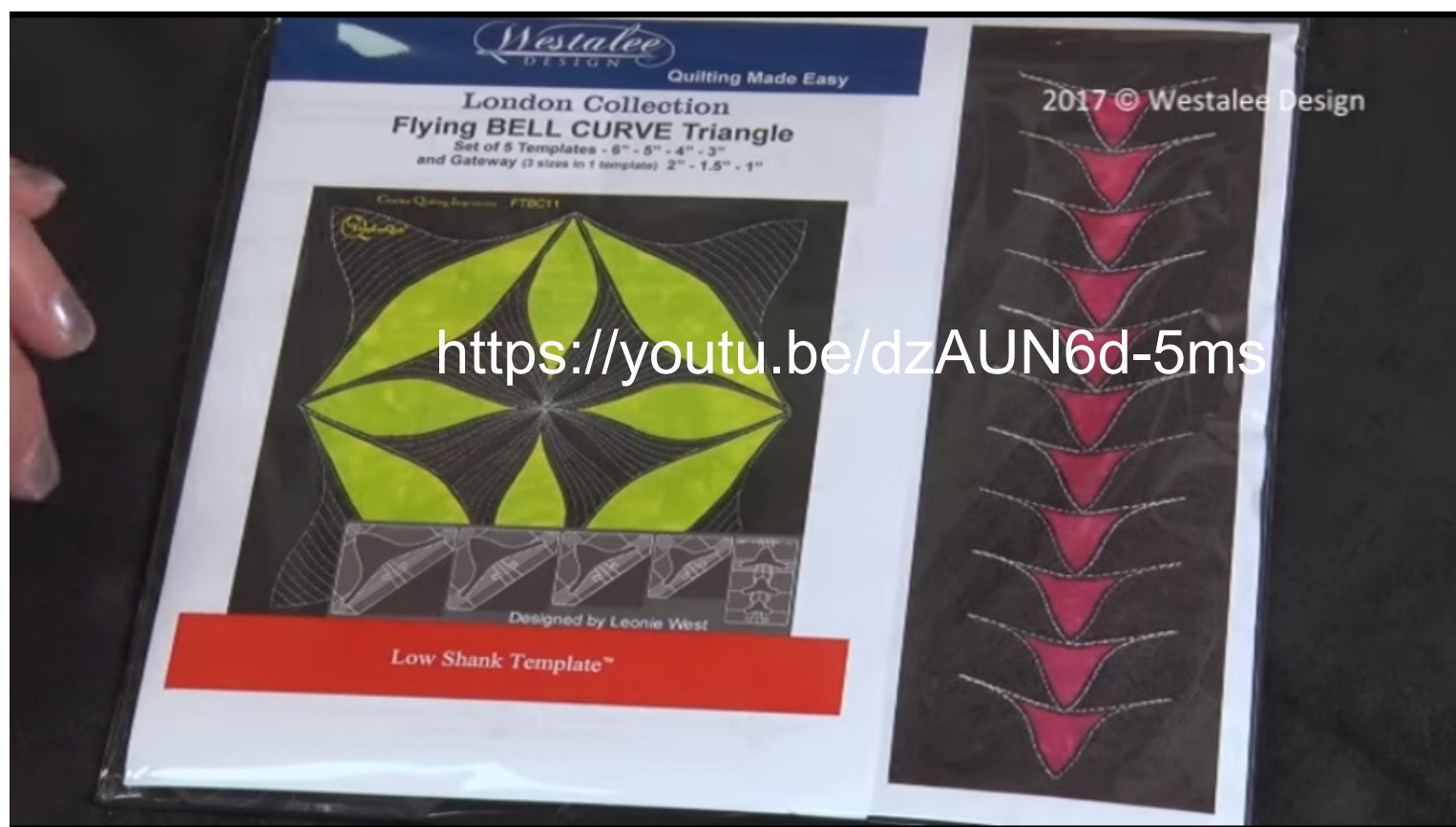

[Click here to purchase HIGH Shank](#) or [here for LOW Shank](#)

Spin-e-Fex Template Sets

Create amazing rotational designs for 5 different block sizes - 4", 6", 8", 9" and 12"

Spin-e-Fex template sets each contain 5 templates to create a rotating design in 5 different sizes: 3½", 5½", 7½", 9½" and 11½".

Use different numbers of rotations to create different effects. The example on the right has 8 rotations. The example below uses the largest template in a 12" block and has 16 rotations. Alternatively, combine sizes as shown in the example below right here where 3½" and 5½" templates have been combined within a 12" block to create a completely different design.



Spin-e-Fex No.10 (8 points)



Spin-e-Fex Template Sets



Spin-e-Fex No.13 (8 points)



Spin-e-Fex No.15 (8 points)

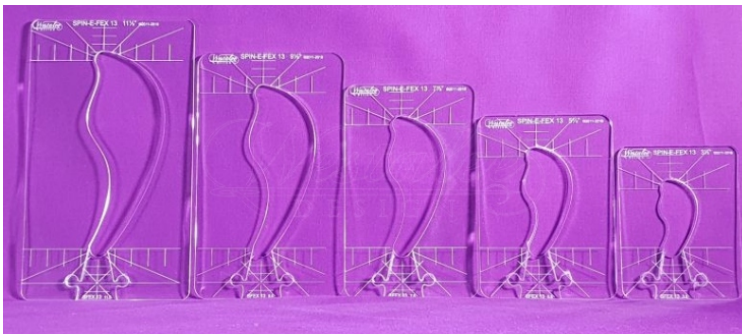

In the example below two smaller sizes of No.15 have been combined in different ways to create new designs.

The video below shows how different sizes of template can be combined in the same rotational design.



Click here to purchase HIGH Shank or here for LOW Shank

Strand of Pearls Template Sets

Strand of Pearls are a continuous line of individual little Pearls travelling around a circle. There are two sizes of pearl, 1" and ½".

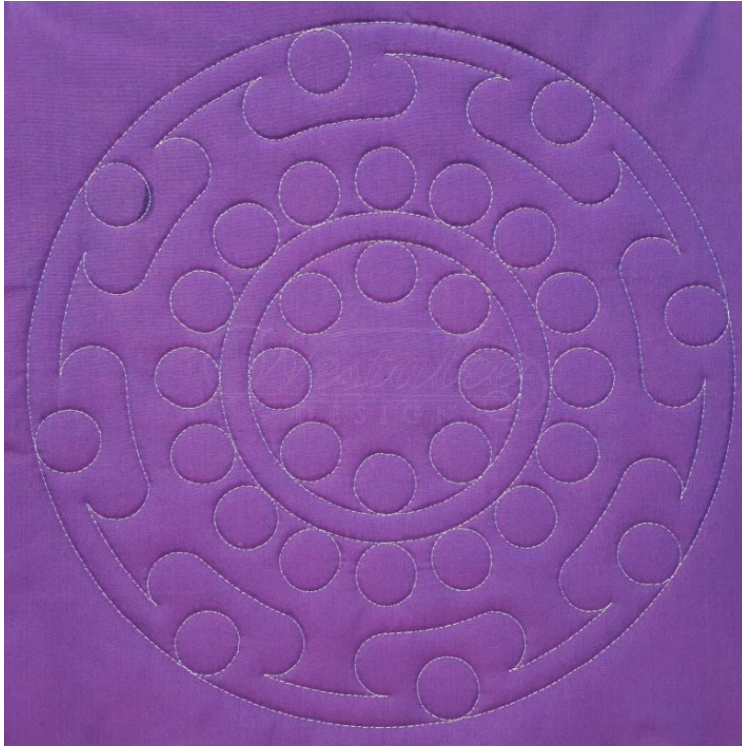

1" Pearls: the Pearls can be stitched on the strand at 16 Rotations or 32 Rotations on the Circle.

There are 5 templates in the set, 3 templates have two sizes on each: 4½", 5½", 6½", 7½", 8½", 9½", 10½" and 11½".



½" Pearls: The Pearls can be stitched on the strand at 16 Rotations or 32 Rotations on the Circle.

There are 5 templates in the set, 4 templates have two sizes on each: 3½", 4½", 5½", 6½", 7½", 8½", 9½", 10½" and 11½".



[Click here to purchase HIGH Shank](#) or [here for LOW Shank](#)

Both these designs are a continuous line of individual little 1" Hearts or Diamonds travelling around the inside of a circle.

Strand of Hearts Template Set



The Hearts can be stitched on the strand at 16 Rotations or 32 Rotations on the Circle.

There are 5 templates in the set, 3 templates have two sizes on each: 4½", 5½", 6½", 7½", 8½", 9½", 10½" and 11½".



Link of Diamonds Template Set

The Diamonds can be stitched on the strand at 16 Rotations or 32 Rotations on the Circle.

There are 5 templates in the set, 3 templates have two sizes on each: 4½", 5½", 6½", 7½", 8½", 9½", 10½" and 11½".



Spin-e-Fex Curly Q's



The Curly Q is a pleasing curvy shape that offers lots of potential for blocks, borders and fills. All the templates have etched markings.

Curly Q's are available in two, 6 template sets:

Curly Q's in **Odd** inch sizes. This set contains 6 templates in odd inch sizes - 1½", 3½", 5½", 7½", 9½" and 11½".

Curly Q's in **Even** inch sizes. This set contains 6 templates in even inch sizes - 2½", 4½", 6½", 8½", 10½" and 11½".

Note that because Spin-e-Fex templates are designed to work in blocks up to 12" the "Even" set includes an 11½" template. It is, however a wider design than the 11½" template supplied in the "Odd" set.

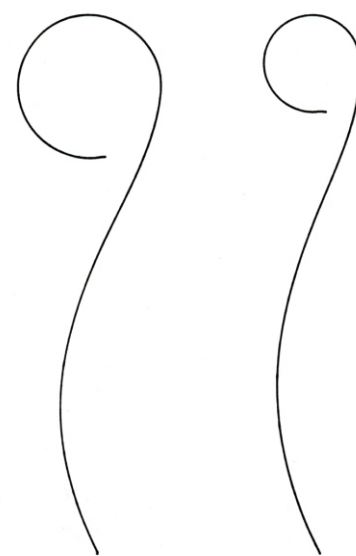

11½"
template
Even Set

11½"
template
Odd Set

[Click here to purchase HIGH Shank](#) or [here for LOW Shank](#)

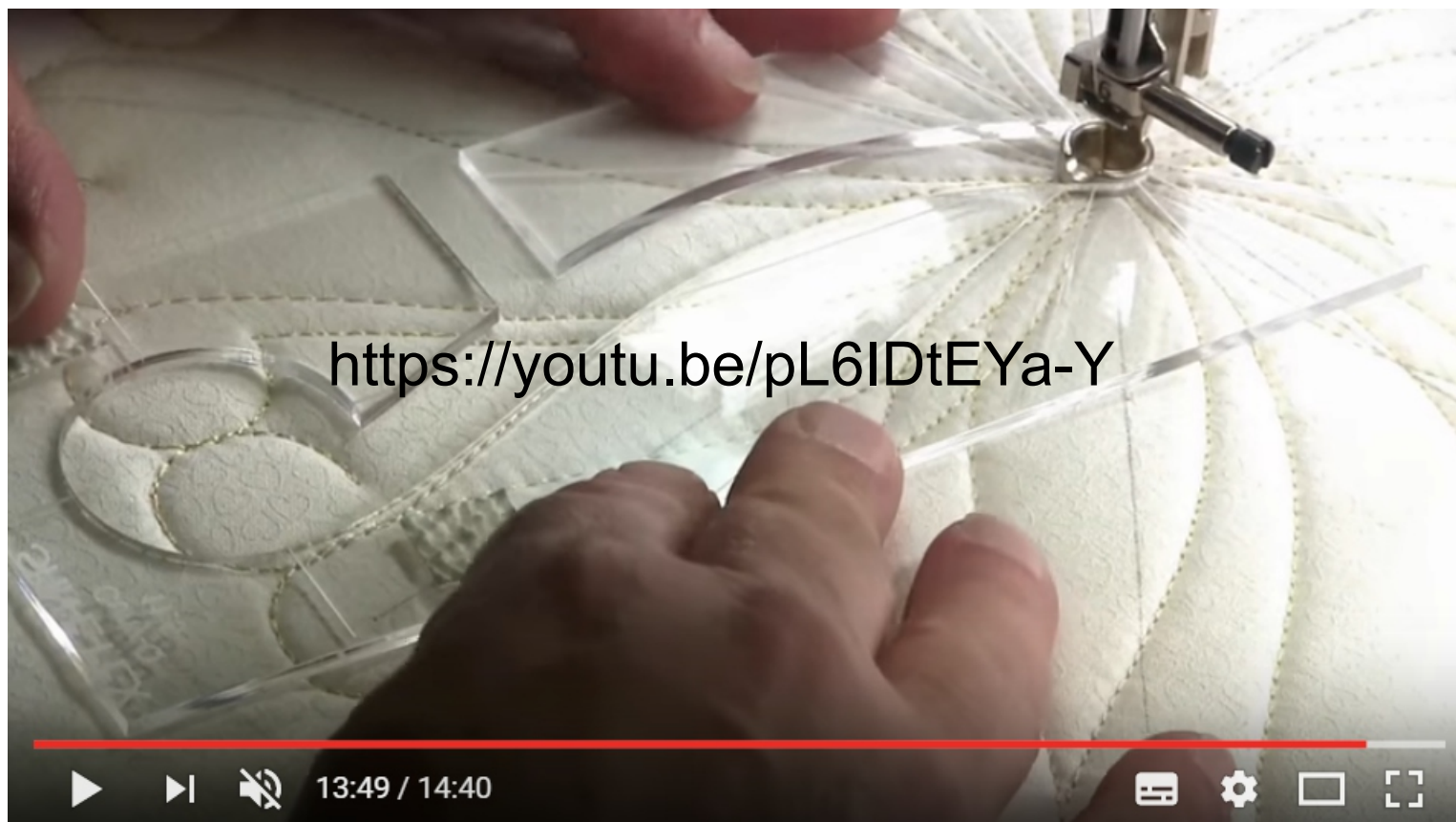

Learn how to create a Curly Q design in this video

Below are some example designs created with Curly Q's showing how it can be adapted for blocks or borders. Note that the actual length of an individual Curly Q is half the stated size. So, for example, the design below left was made using an 11½" Curly Q. The diameter of the completed design would be 11½" (the length of each individual Curly Q is 5¾"). In the design on the right the corners have been stitched using an Arc ruler and Between-the-Lines templates



[Click here to purchase HIGH Shank](#) or [here for LOW Shank](#)

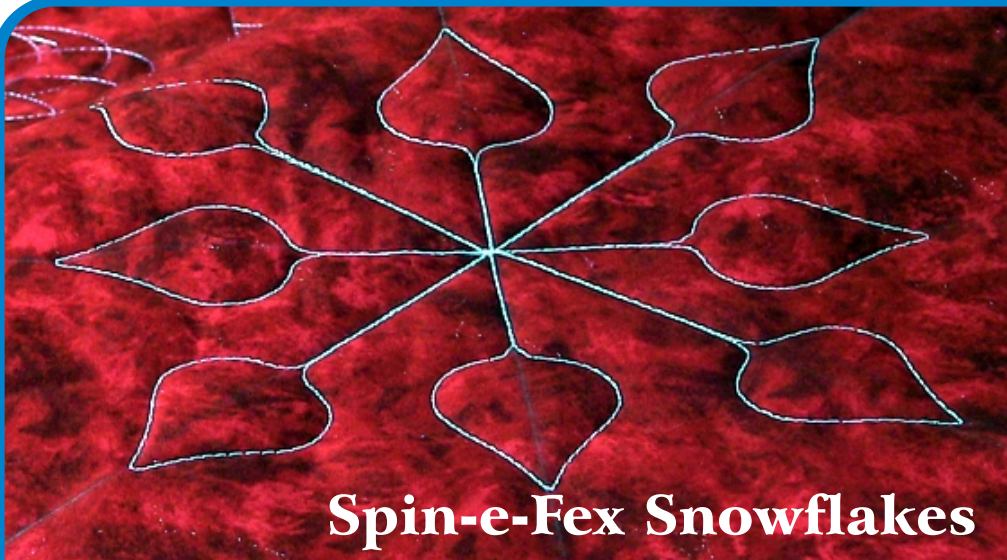

Spin-e-Fex Snowflakes

It may sound seasonal, but the Snowflake template set offers more than just quilting designs for your Christmas projects.

This 8 piece set comes at a price so what makes it worth the investment. The answer is variety!

There are four basic Snowflake “tip” designs as shown below. Each design comes as a pair of templates giving two tip sizes. In addition there are 4 “keys” with each design pair that allow you to vary the length of the snowflakes. The result is a very flexible template pack offering lots of design options.

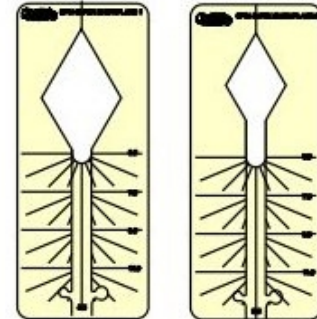

Design 1

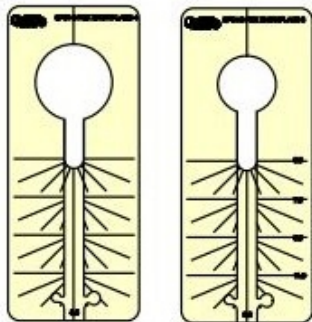
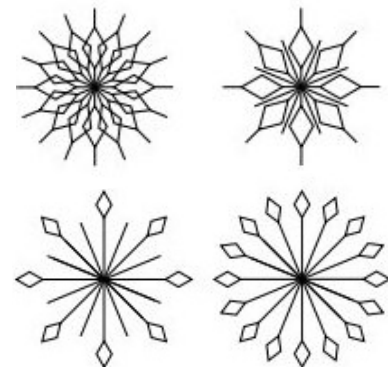

Design 2

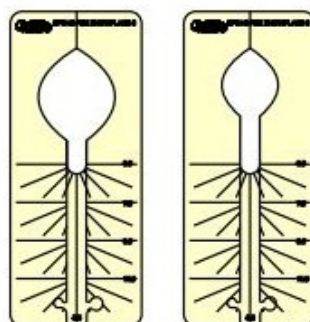
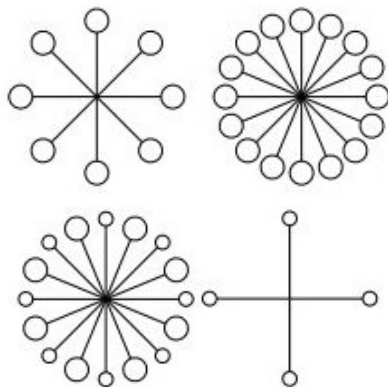

Design 3

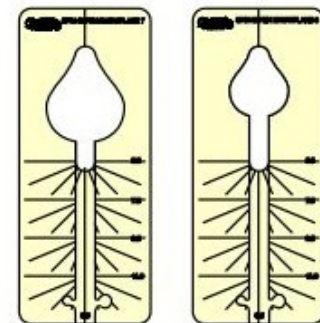
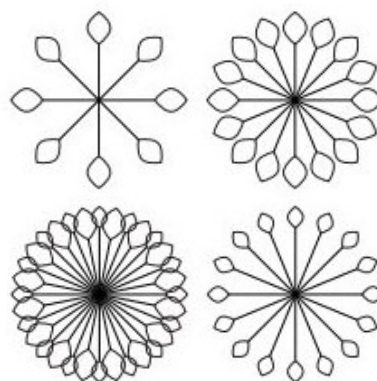

Design 4

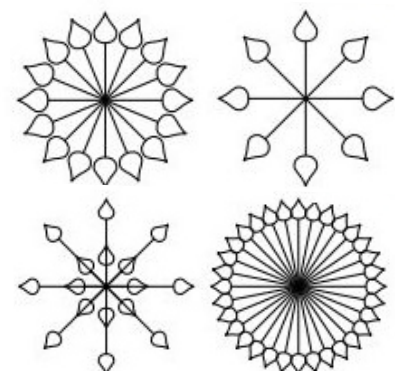

[Click here to purchase HIGH Shank](#) or [here for LOW Shank](#)

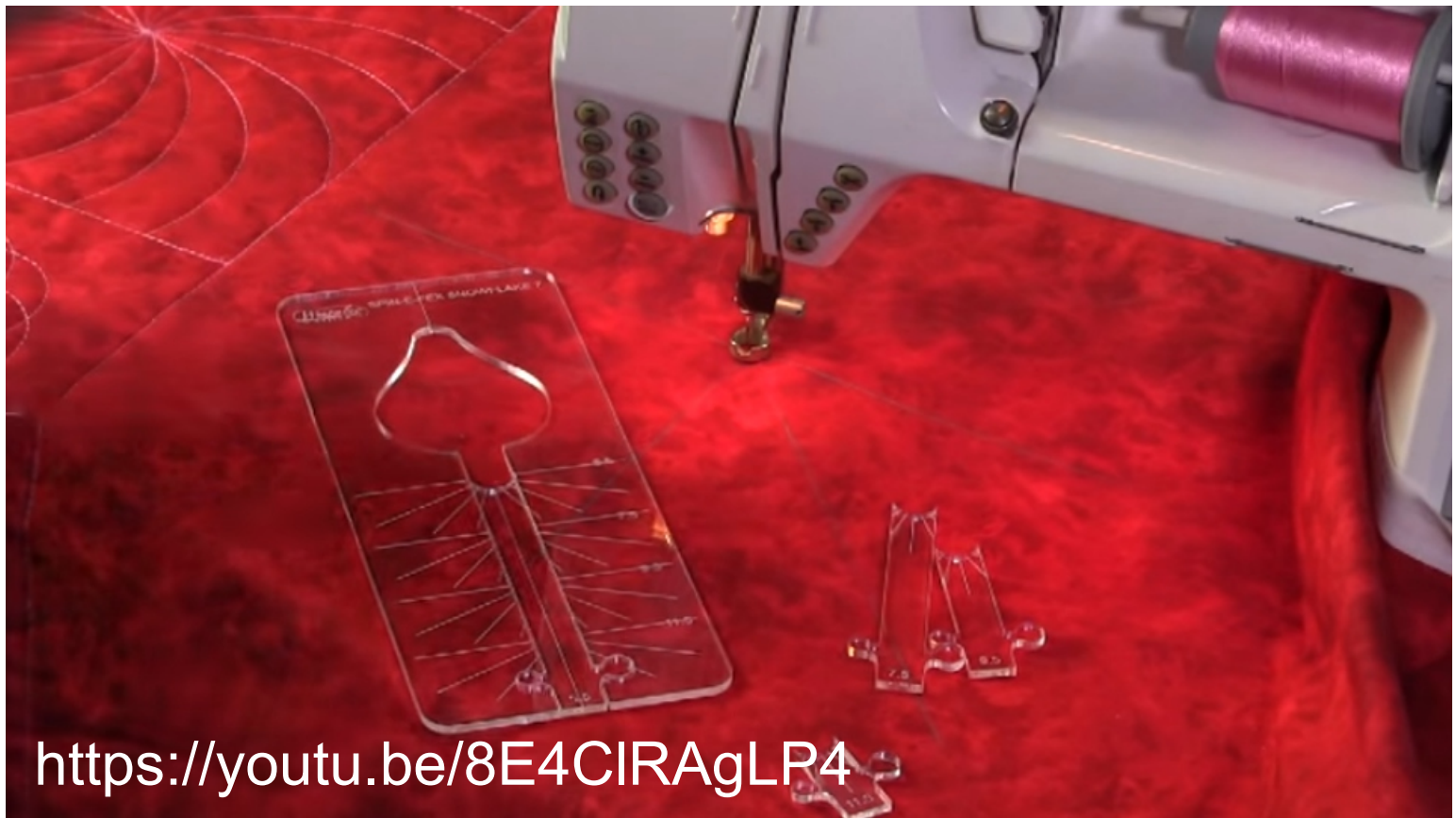

Learn how to create a snowflake design in this video

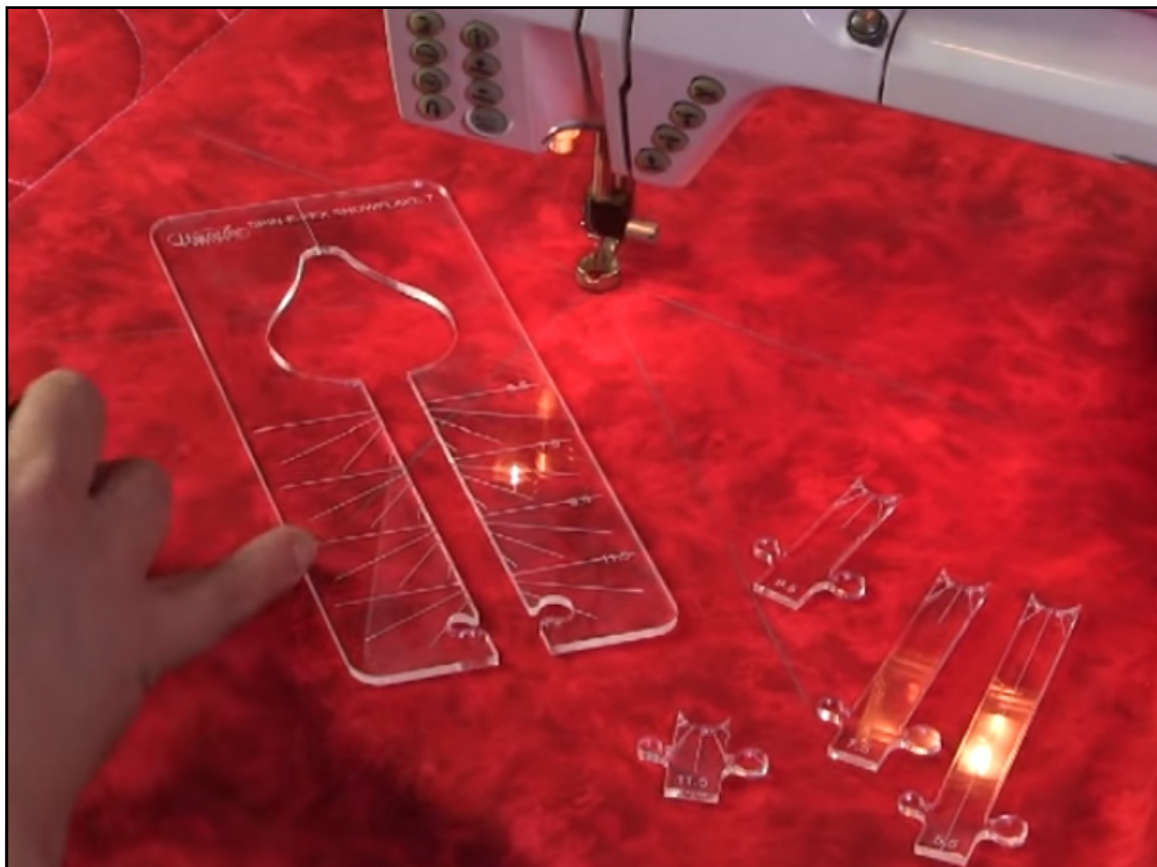

This still from the video shows the template along with the four interchangeable keys that allow you to alter the length of the design in an accurate and consistent way.

All of the templates have etched markings so that you can rotate the design quickly and accurately.

Click here to purchase HIGH Shank or here for LOW Shank

Spin-e-fex Feather Template Set

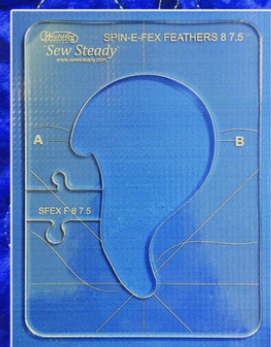

Spin-e-fex Feathers
Available in 2", 3", 4" and 5"

This rotating template allows you to create circular feather designs and can be combined with other Circles on Quilts templates.

Many of the templates have a unique "key gate" - a removable piece of the template that allows you to place the foot inside the template and then close the opening.

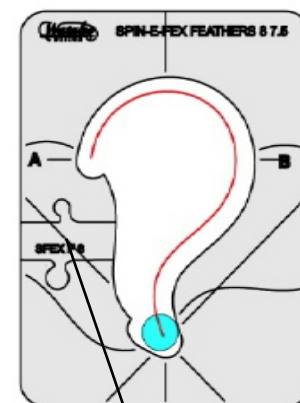
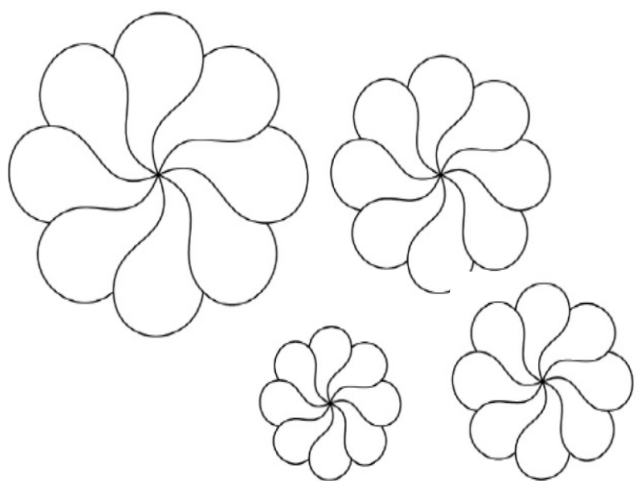

Key Gate

The set includes four different size templates for creating 7½", 5½", 4½" and 3½" feathers. All templates have etched markings that are easy to see. The reference lines help you to keep the feathers on track. You will find more information in this video.



Rotating Templates

Spinning Wheels and Wreaths

For accuracy these templates use a single pin as the point of rotation. The size indicates the size of the block the design fits into.

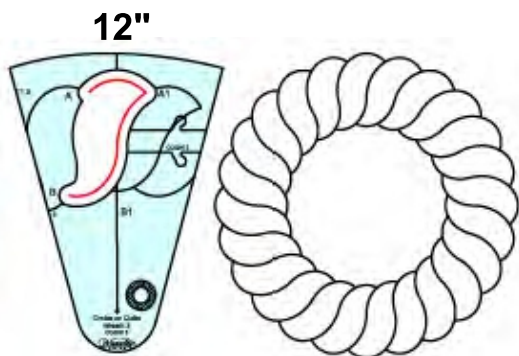
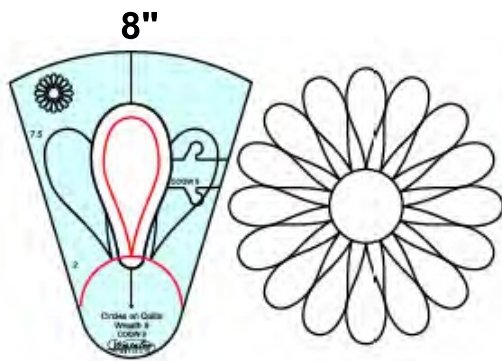
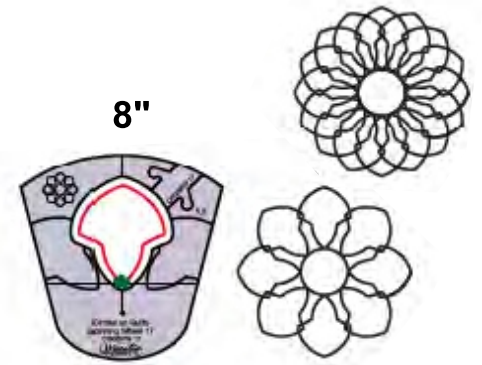
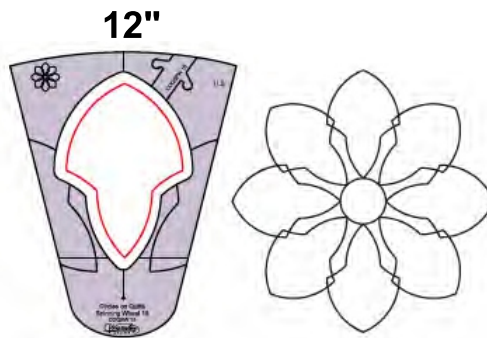
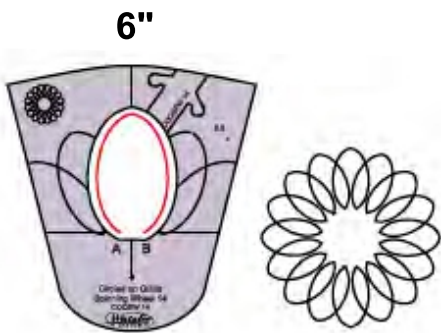
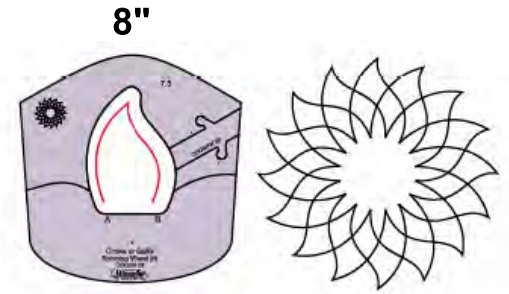
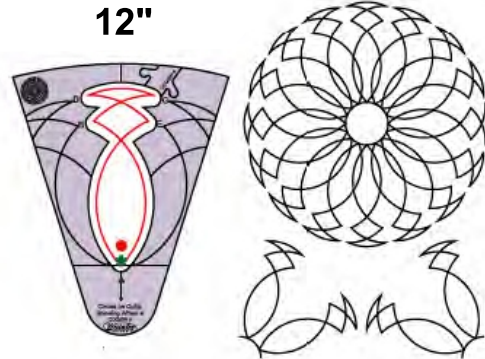
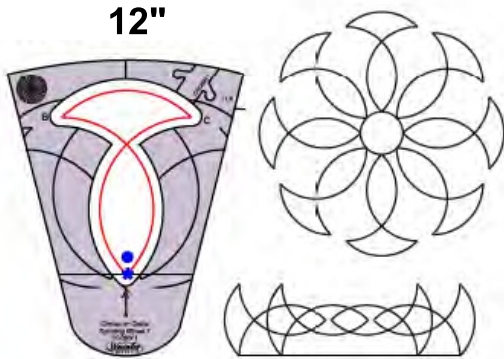

[Click here to purchase HIGH Shank](#) or [here for LOW Shank](#)

Honeycomb

This versatile template can be used to create 3.5" - 5.5" - 7.5" - 9.5" - 11.5" - 13.5" and 15.5" designs.

Designs can be created with 6 - 8 - 12 - 16 - 24 or 32 rotations. For improved accuracy mark out your rotations with an 8-point or 6-point Crosshair Ruler.

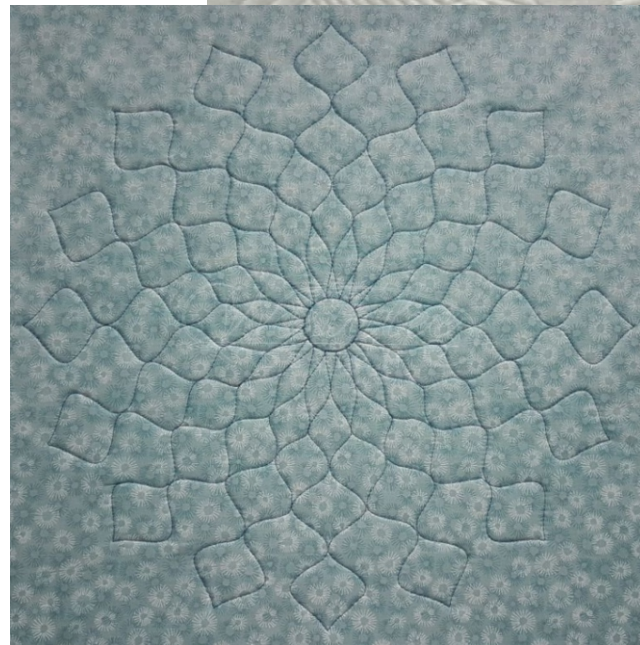
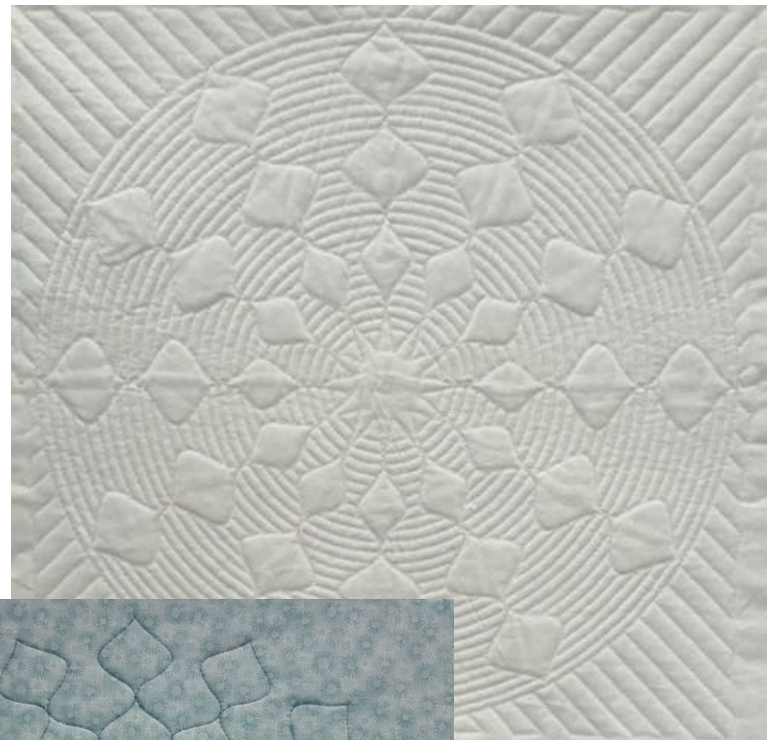

For more information watch the video below.



Click here to purchase HIGH Shank or here for LOW Shank

Circle on Quilts Wreath 41

A classical wreath with a new twist. Wreath 41 uses the Pin locating System and has 12 Rotations. Can also be used to make 16 – 24 – 32 Rotation Wreaths.

Use more than 1 Wreath size to open up the design potential.

Five template set. The approximate diameters are: 3½", 5½", 7½", 9½", and 11½".

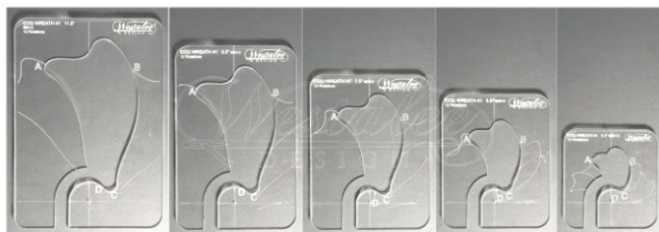

Yin and Yang

The Yin and Yang Template is quick and easy to quilt. Combining the traditional Yin and Yang design with Leonie's variation in 1 Template allows you to create many more designs.

Five template set. The circle diameter sizes are 1", 1½", 2", 2½" and 3".

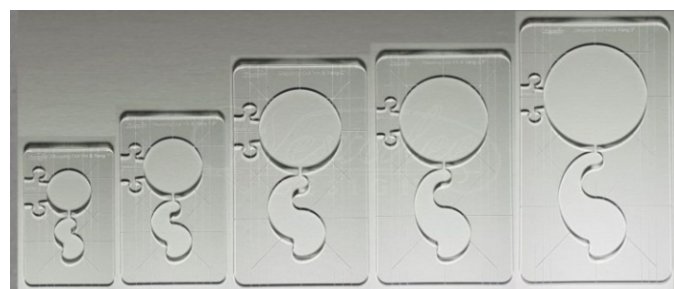

Continuous Hearts

Create a beautiful border to complement your block quilting.

Each template set contains two “nested” templates (both templates are cut from a single piece of acrylic as shown right).

The Continuous Hearts Small set contains two templates for stitching borders either 2" or 3" high.

The Continuous Hearts Large set contains two templates for stitching borders 4" or 6" high.

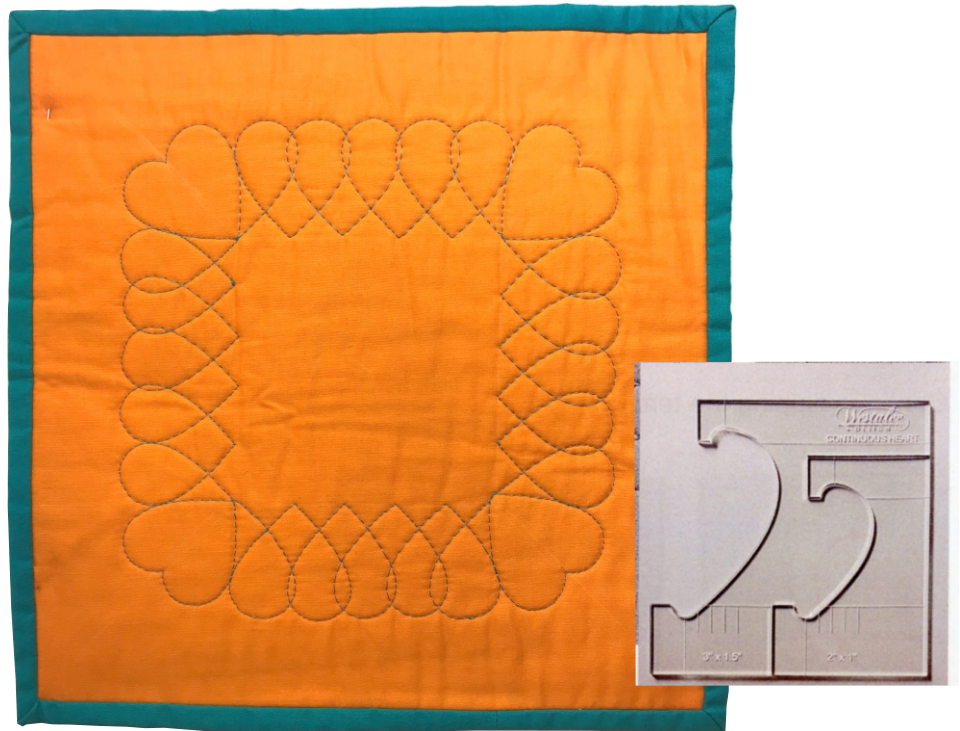

Stitch one row point to point above another to create an interesting double width border (right). Find out more about these templates in this video.

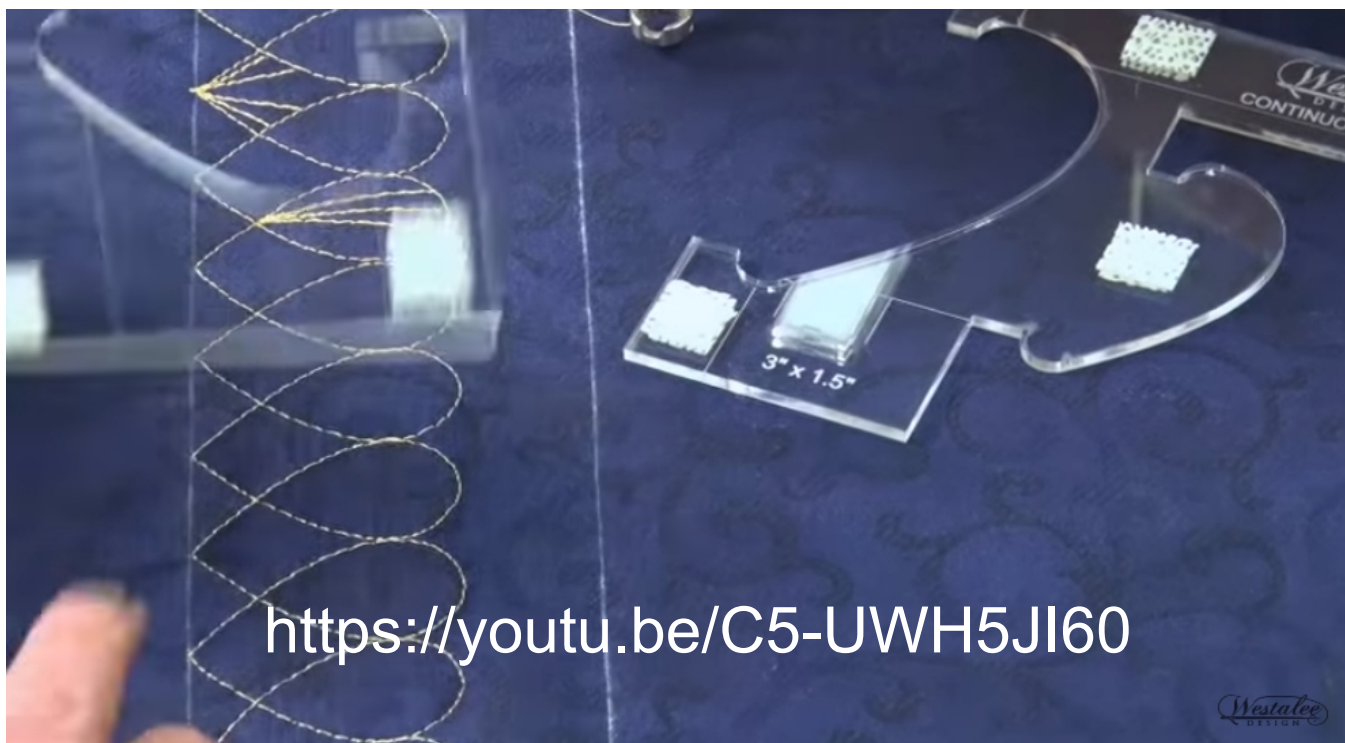
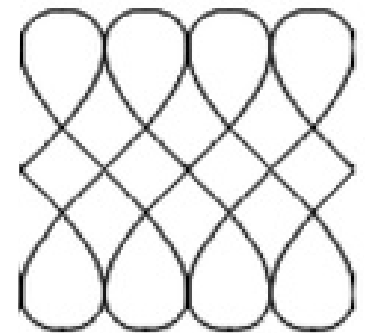

<https://youtu.be/C5-UWH5JI60>

Click here to purchase HIGH Shank or here for LOW Shank

Hearts Template Set

This 6 piece template set helps you create beautiful hearts. Sizes range from 1" - 6" in 1" increments.

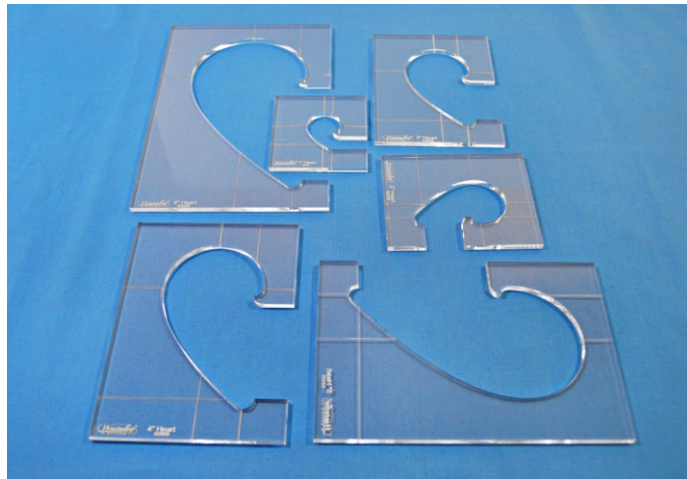

Apple Core Set

Create continuous background fill designs and much more with this 3 piece set.

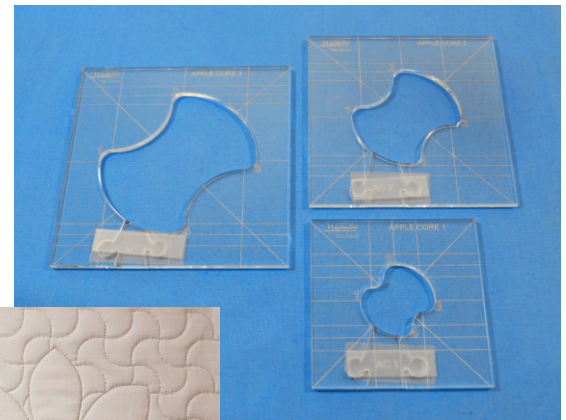

Template sizes from 1" - 3"



[Click here to purchase HIGH Shank](#) or [here for LOW Shank](#)

Janet's Ruler Quilt Design Book

Master your skills with Westalee Rulers by creating this wholecloth quilt. Using the templates supplied with the Ruler Foot and Sampler Set 1 Janet has created a quilt design that will help you learn and give you ideas on how to use these templates in future quilts. [Click here](#) to return to see the "Quilt As You Go" Class Set that includes the Westalee Foot, Sampler Set and Cross Hair Square required for this book.

Finished size 60" x 40"

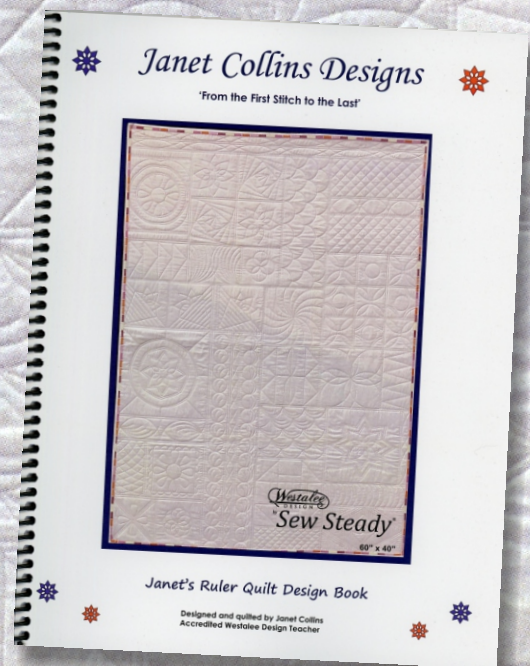

Westalee
DESIGN

[Click here to purchase at www.cottonpatch.co.uk](http://www.cottonpatch.co.uk)

Ruler Foot Shank Fittings by Manufacturer

Below is a list of the most popular manufacturers and which feet their machines require. Please note that this list is not comprehensive and is subject to change as new machines are introduced.

Bernina (an adapter is required)

Low Shank - all **except** 7 and 8 series, see below

Medium Shank - 820 QE, 830E LE, 880E LE, B710, B740, B750QE, B770, B780, B790

Babylock

Low Shank - most except as noted below

High Shank - Aria Blar, Cresendo, Destiny, Journey, Spirit, Unity, Ellageo, Sofia

High Shank Special - BLQP, BL500, BL500A

Brother

Low shank - all except as noted below

High shank - Dream Creator VM and VQ, Dream Weaver, NV6000D, Quattro, Super Galaxie, V5, V7, VE2200, VM5100, VM6200, VQ2, VQ2400, VQ3000, XV8500D

High Shank Special - PQ1300, PQ1500, PQ1500s, Prestige 270, Prestige 270, Nouvelle 1500, 1500s

Janome

Low Shank - all except as noted below

High Shank - Horizons and Memory Craft 6600P and above, Ateliers

High Shank Special - 1600P DB, 1600P DBX, 1600P QC

Juki

Low Shank - DX7, DX2000QVP, HZL-F300, HZL-F400, HZL-F600, HZL-G100W, HZL-G110, HXL-G210

High Shank - DDL-227, DDL-555, DDL-8700, TL-2000Qi, TL-2010Q, TL-2200QVP, TL-98E, TL-98P, TL98QE

Ruler Foot Shank Fittings by Manufacturer

Pfaff

Low shank - all except as noted below

Medium Shank - Expression – 150th Ann Edition, 2.0, 3.0, 3.5

- Creative - 1.5, 2.0, 3.0, 4.0, 4.5, Performance, Sensation Pro, Icon, Vision

- Performance 5.0

- Quilt Expression - 3.2, 4.0, 4.2

High Shank - 1197, 1199, 1209, 1211, 1212, 1213, 1214, 1215, 1216, 1217, 1221, 1222, 1222E, 1222SE, 1229

High Shank Special - 1200 Grand Quilter

Singer

Slant Foot - all Slant Shank machines

Low shank - Modern Quilter, Confidence series (7363, 7465, 7462, 7463, 7466, 7467, 7468, 7469, 7470)

High Shank Special - 2OU 31-15, 1191-D300A

Viking

Low shank - all except as noted below

High Shank Special - Mega Quilter

Note that there is not a foot available for Viking No 1.

