

PFAFF

GrandQuilter

Owner's manual



This household sewing machine is designed to comply with IEC/EN 60335-2-28 and UL1594

IMPORTANT SAFETY INSTRUCTIONS

When using an electrical appliance, basic safety precautions should always be followed, including the following: Read all instructions before using this household sewing machine.

DANGER - To reduce the risk of electric shock:

- A sewing machine should never be left unattended when plugged in. Always unplug this sewing machine from the electric outlet immediately after using and before cleaning.
- Always unplug before relamping. Replace bulb with same type rated 12V, 5 Watt.

WARNING - To reduce the risk of burns, fire, electric shock, or injury to persons:

- Do not allow to be used as a toy. Close attention is necessary when this sewing machine is used by or near children or infirm person.
- Use this sewing machine only for its intended use as described in this manual. Use only attachments recommended by the manufacturer as contained in this manual.
- Never operate this sewing machine if it has a damaged cord or plug, if it is not working properly, if it has been dropped or damaged, or dropped into water. Return the sewing machine to the nearest authorised dealer or service center for examination, repair, electrical or mechanical adjustment.
- Never operate the sewing machine with any air openings blocked. Keep ventilation openings of the Sewing machine and foot controller free from the accumulation of lint, dust, and loose cloth.
- Keep fingers away from all moving parts. Special care is required around the sewing machine needle.
- Always use the proper needle plate. The wrong plate can cause the needle to break.
- Do not use bent needles.
- Do not pull or push fabric while stitching. It may deflect the needle causing it to break.
- Switch the sewing machine off ("0") when making any adjustment in the needle area, such as threading needle, changing needle, threading bobbin, or changing presser foot, etc.
- Always unplug the sewing machine from the electrical outlet when removing covers, lubricating, or when making any other user servicing adjustments mentioned in the instruction manual.
- Never drop or insert any object into any opening.
- Do not use outdoors.
- Do not operate where aerosol (spray) products are being used or where oxygen is being administered.
- To disconnect, turn all controls to the off ("0") position, then remove plug from outlet.
- Do not unplug by pulling on cord. To unplug, grasp the plug, not the cord.
- Hold plug when rewinding into cord reel. Do not allow plug to whip when rewinding.

SAVE THESE INSTRUCTIONS

Congratulations on purchasing your new GrandQuilter!

Your GrandQuilter is so easy to use and will, together with your imagination, create wonderful quilts. Please spend some time reading these operating instructions as it is a great way to learn the machine and also to make full use of its features.

Your Pfaff dealer will be at your service with any help or advice you need.

We wish you many enjoyable hours of sewing and quilting!

VSM Group AB

Some fabrics have excess dye which can cause discoloration on other fabric but also on your sewing machine. This discoloring may be very difficult or impossible to remove.

Fleece and denim fabric especially in red and blue often contains a lot excess dye.

If you suspect that your fabric/ready to wear garment contains a lot of excess dye, always pre-wash it before sewing/embroidering to avoid discoloring.

Table of content

1. Introduction

Machine overview	4
Standard accessories	6
Extra accessories	7
Needle chart	8

2. Operating your GrandQuilter

Carrying handle	10
Soft cover	10
Electrical connection	11
Connecting the foot control	11
Controlling sewing speed	12
Foot control	12
Speed control slide	12
Bobbin winding button	13
Thread cutter	13
Needle Up/Down	13
Stitch length dial	14
Reverse lever	14
Presser foot lifter	14
Pressure dial	15
Knee lift	15
Changing the presser foot	16
Changing the needle	16
Attaching the darning plate	17
Placing a thread spool on the spool pin	17
Placing a thread cone on the spool pin	17
Bobbin winding	18
Inserting a bobbin	19
Inserting a bobbin into the hook	20

To remove the bobbin case and bobbin	20
Threading the machine	21
Needle threader	23
Bringing up the bobbin thread	24
Balancing the thread tension	25
Attaching the extension table	26

3. Getting started

Getting started to sew	28
Turning a corner	29
Using the Fabric guide	29
How to use the Free-motion foot	30
Quilting	31
Stitch-in-the-ditch	31
Free-motion stippling	32

4. Maintenance and troubleshooting

Cleaning the hook and feed dogs	34
Oiling the machine	35
Changing the light bulb	36
Troubleshooting	37
Index	39



Introduction

Machine Overview

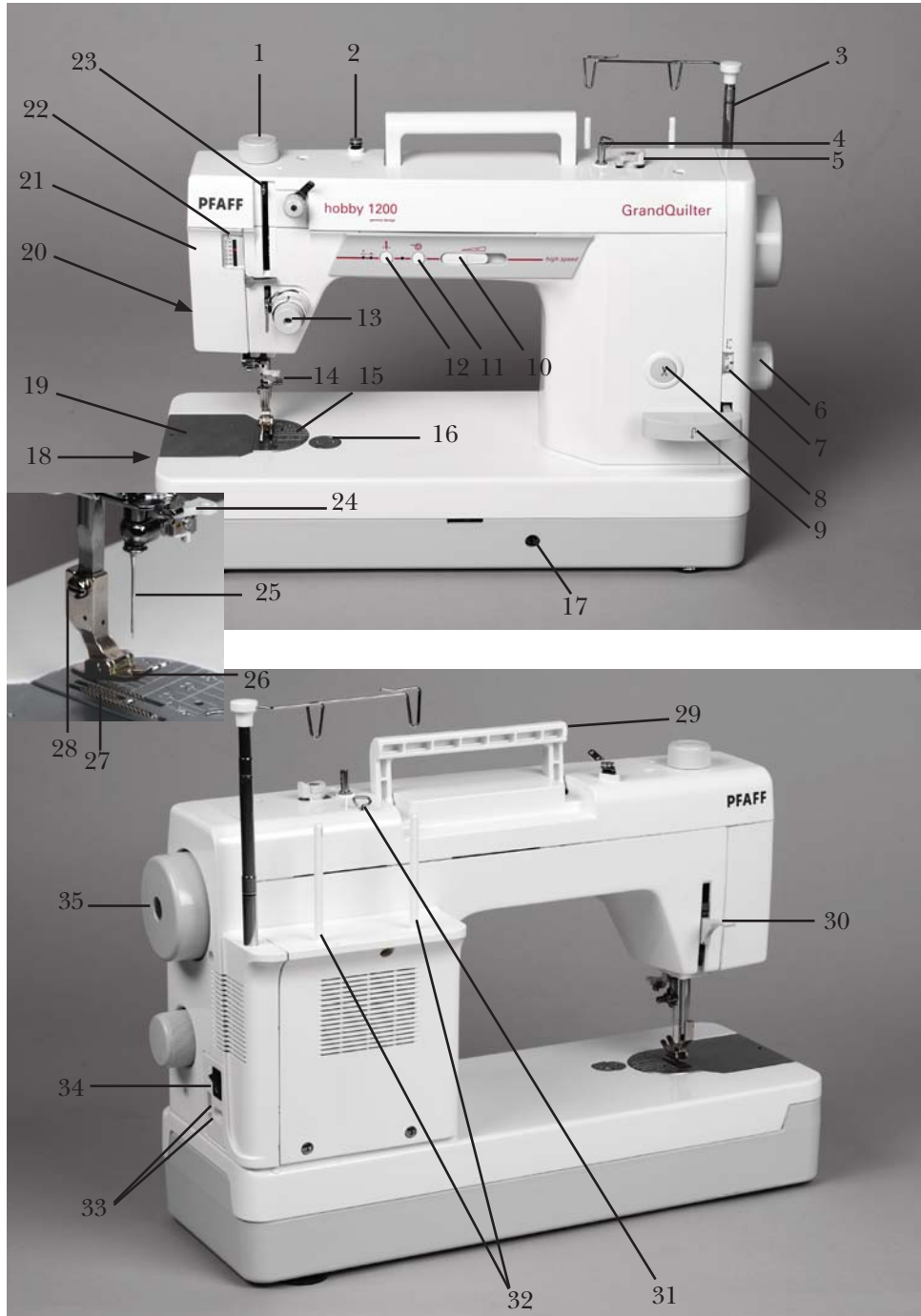

Machine Overview

1. Pressure dial
2. Bobbin winding tension disk
3. Thread stand
4. Bobbin winder spindle
5. Bobbin winder stop
6. Stitch length dial
7. Stitch length indicator
8. Thread cutter button
9. Reverse lever
10. Speed control slide
11. Bobbin winding button
12. Needle Up/Down button
13. Thread tension dial
14. Needle clamp screw
15. Needle plate
16. Attachments holes
17. Knee lift socket
18. Bobbin case cover
19. Hook cover plate
20. Thread cutter
21. Face cover
22. Pressure indicator
23. Take-up lever
24. Needle threader
25. Needle
26. Presser foot
27. Feed dogs
28. Set-screw
29. Carrying handle
30. Presser foot lifter
31. Thread guide for bobbin winding
32. Spool pins
33. Machine sockets
34. Power switch
35. Handwheel

Standard accessories

1. Accessory box
2. Free-motion foot
3. Standard foot
4. Spool holder
5. Fabric guide
6. Screw for the fabric guide
7. Spool cap
8. Darning plate
9. Oil
10. Lint brush
11. Bobbins
12. Small screwdriver
13. Large screwdriver
14. Net
15. Needles
16. Soft cover
17. Knee lift
18. Foot control



19. Extension table



Extra accessories



Leather foot
Article no: 416 04 81-01



Silk foot
Article no: 416 04 83-01



Rolled hem foot
Article no: 416 04 85-01



Zipper foot
Article no: 416 04 82-01



Walking foot
Article no: 416 04 84-01

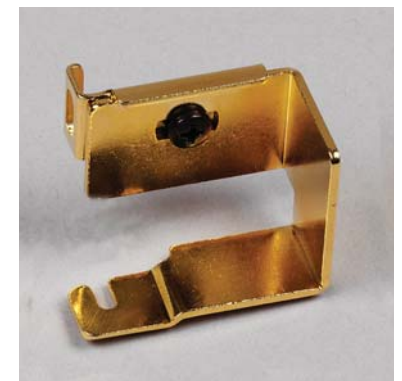

Velvetfoot
Article no: 416 04 86-01

Needle chart

	Fabrics	Thread	Needle (HL x 5) size
Light weight	Crepe de chine, Voile, Lawn, Organdy, Georgette, Tricot	Fine silk, fine cotton, fine synthetic or covered polyester	9 or 11
Medium weight	Linens, Cotton, Pique, Serge, Double Knits, Percale	50 silk, 50 to 80 cotton, 50 to 60 Synthetic, cotton covered polyester	11 or 14
Heavy weight	Denim, Tweed, Gabardine, Coating, Drapery and Upholstery Fabric	50 silk, 40 to 50 Cotton, 40 to 50 Synthetic, Cotton Covered Polyester	14, 16 or 18

Operating your GrandQuilter



Carrying handle

Lift up the carrying handle of the sewing machine from behind.



Soft cover

The soft cover, which is part of the basic equipment, protects your sewing machine from dust and damage while transporting.

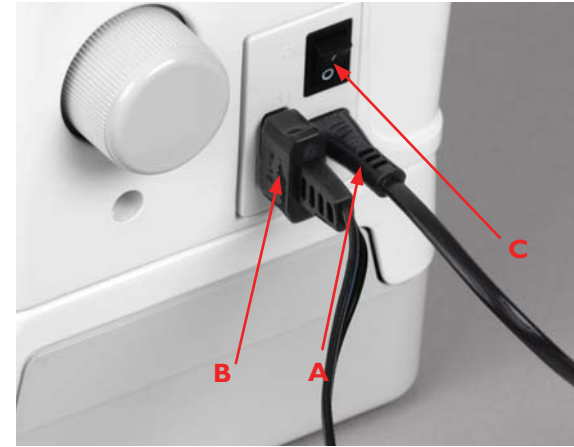

Electrical connection

⚠ Before connecting to the power supply, make sure the voltage shown on the machine conforms to your electrical power. Always turn the power off and unplug the sewing machine from the electrical outlet when the machine is not in use.

Connect the lead cord between the socket of the sewing machine (A) and the wall outlet.

For the USA and Canada:

This sewing machine has a polarized plug (one blade wider than the other). To reduce the risk of electric shock, this plug is intended to fit in a polarized outlet only one way. If the plug does not fit fully in the outlet, reverse the plug. If it still does not fit, contact a qualified electrician to install the proper outlet.

DO NOT modify the plug in any way!



Connecting the foot control

⚠ Switch off the main switch.

Connect the plug of the foot control (B) to the connection socket of the sewing machine.

Turn on the power switch (C).

Controlling sewing speed

You can control the sewing speed on your machine in two ways; with your foot control and with the speed control slide on your sewing machine.

Foot control

On your GrandQuilter you can control the sewing speed by using your foot control. The harder you press the foot control, the faster the machine runs.

If you press the foot control to the bottom, the machine runs at the maximum speed set by the speed control slide.

Note: Make sure you have the right type of foot control for your machine. Foot Control model YC-485 is used for the GrandQuilter.



Speed control slide

With the speed control slide on your GrandQuilter, you can change the sewing speed to suit your needs. For instance when making freehand quilt designs/stippling, lower the the sewing speed to avoid jump stitches.

To raise the sewing speed, slide the bar to the right.

To lower the sewing speed, slide the bar to the left.



Bobbin winding button

Press the bobbin winding button on your GrandQuilter to wind the bobbin. The light beside the button will light up while you are winding the bobbin. When the bobbin is full, the GrandQuilter will automatically stop and the bobbin light will be turned off.

Note: With your GrandQuilter you can wind the bobbin while sewing.



Thread Cutter

The thread cutter button on your GrandQuilter helps you trim the top and bobbin thread while sewing.

After trimming the threads you can continue sewing without having to pull the bobbin thread to the top.

Note: If you are using a thread thicker than 30, use the the thread cutter on the face cover. You cannot use the footcontrol or the Needle Up/Down while you are trimming the threads.

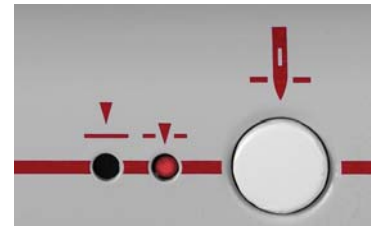

Needle Up/Down

The Needle Up/Down function on your GrandQuilter is useful when you are turning a corner on your quilt. Press the Needle Up/Down button to bring the needle bar up or down. When the needle is down the red indicator next to the button will light up. When the needle is up the green indicator will light up.

Your GrandQuilter will stop with the needle up or down depending on which light is switched on. After using the Thread Cutter your GrandQuilter will always stop with the needle in the up position.

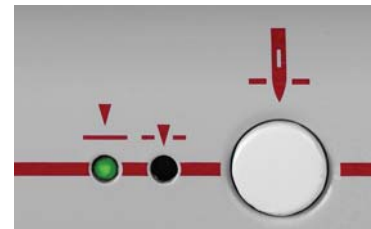

Stitch length dial

The stitch length can be adjusted on your GrandQuilter by turning the stitch length dial located on the side of your machine. The stitch length can be adjusted from 0 to 6 mm. On the front of the machine there is an indicator showing the stitch length.



Reverse lever

Sewing in reverse will help you to secure the beginning and end of seams. When you press the reverse lever downwards, the machine will sew in reverse. The machine will only sew in reverse as long as the reverse lever is pressed down.

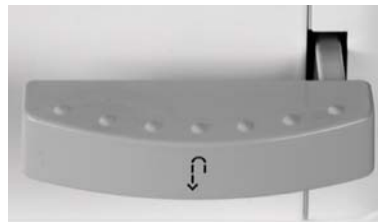

Presser foot lifter

You can raise or lower the presser foot by raising or lowering the presser foot lifter (A). You can also raise the foot higher than the normal up position to help you place thick material under the foot.

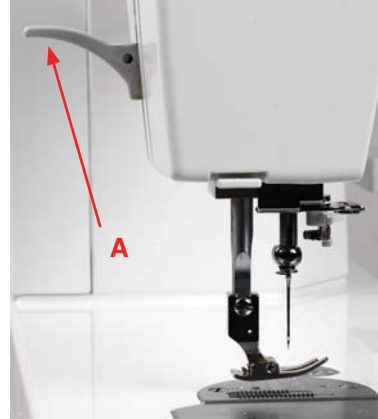

Pressure dial

Turn the pressure dial to adjust the pressure of the presser foot when sewing on different thicknesses of fabric.

For heavy fabrics or when sewing on several layers of fabric, you should raise the pressure. When sewing on thin fabric you should lower the pressure. For regular sewing set the pressure to 3.

Note: Do not reduce the pressure lower than "0".



Knee lift

Your GrandQuilter is provided with a kneelifter for regulating the presser foot height. It is especially useful when you need both of your hands to guide the fabric.

1. Insert the kneelift by matching the ribs on the knee lift (A) with the notches in the kneelifter socket.
2. Push the kneelift with your knee sideways to raise and lower the presserfoot.

To remove the kneelift, pull it gently out of the hole.

Note: Avoid touching the knee lift while sewing, as the fabric will not be fed smoothly.



Changing the presser foot

 **Switch off the main switch and unplug the machine.**

1. Raise the presser foot lifter. Loosen the setscrew (A) with the large screwdriver.
2. Choose the proper foot and insert it from the bottom.
3. Tighten the setscrew with a large screwdriver to secure the foot.

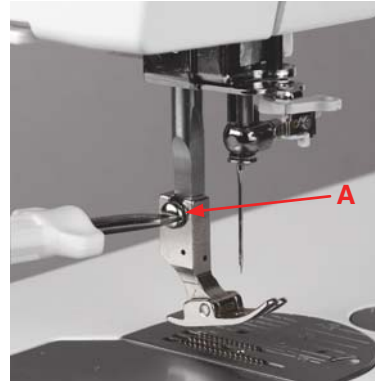

Changing the needle

 **Switch off the main switch and unplug the machine.**

1. Lower the presser foot.
2. Using the large screwdriver, turn the needle clamp screw counter-clockwise.
3. Loosen the screw and remove the needle from the needle clamp (B).
4. Insert a new needle into the needle clamp (B). Make sure that the flat side is to the right. Push the needle as far as it will go and then tighten the clamp screw (C) firmly.

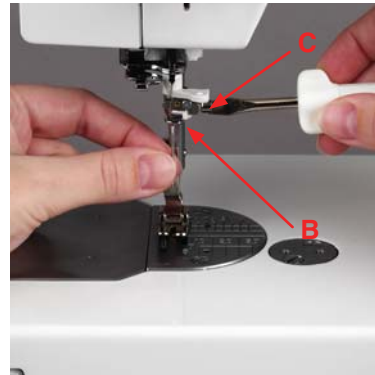

Note: Use an HL x 5 needle.

To check for a good needle

Put the flat side of the needle onto something flat (needle plate, glass etc.).

The gap between the needle and the flat surface should be consistent.

Never use a blunt needle. A damaged needle can cause permanent snaps or runs in knits, fine silks and silklike fabrics.

Note: Check the needle frequently for barbed or blunted points.

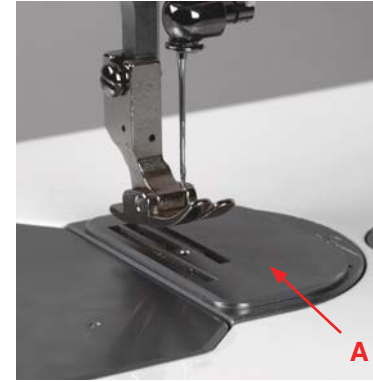
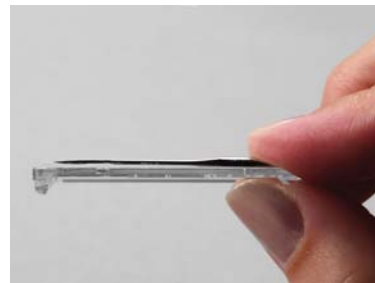

Attaching the darning plate

If you want to feed the fabric manually, for instance when stippling, you should use the darning plate (A) that has been provided with your GrandQuilter.

To attach the darning plate you should start by raising the presser foot lifter. Raise the needle to its highest position by pressing the Needle Up/Down button twice.

 **Switch off the main switch and unplug the machine.**

Attach the darning plate by matching the pins on the darning plate with the holes in the needle plate.

Placing a thread spool on the spool pin

Place a spool of thread on the spool pin and put a large spool cap firmly against the spool. The thread should come off the spool as shown in the picture.



Placing a thread cone on the spool pin

If you are using a large thread cone, use a spool holder to hold the cone in place. Put the spool holder (B) on the spool pin, then place the thread cone on the spool holder.

Note: If the spool is wobbly when sewing, cover the thread cone with the net that comes with the machine.





9. Cut the thread with scissors. Remove the bobbin from the bobbin winder spindle.
Note: This machine has an exclusive motor for bobbin winding, which allows you to wind a bobbin while sewing.

Bobbin winding

1. Pull the thread stand up as far as it will go and turn it around until it clicks into position.
2. Pass the thread through the guide (A) on the thread stand from behind.
3. Pass the thread through the second thread guide (B).
4. Pass the thread under the bobbin winding tension disk (C).
5. Thread through the hole (D) in the bobbin from the inside to the outside. Place the bobbin on the bobbin winder spindle by matching the hole on the bobbin with the spring on the bobbin winder spindle (E).
6. Push the bobbin winder stop to the left (F).
7. Hold the end of the thread and press the bobbin winding button. Press the bobbin winding button again to stop the bobbin when it has made several turns, and cut the thread close to the hole in the bobbin.
8. Press the bobbin winding button again. The machine will stop automatically when the bobbin is full and the bobbin winder stop will return to the original position.

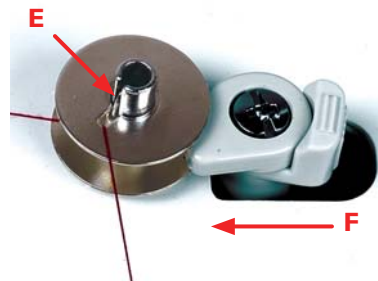
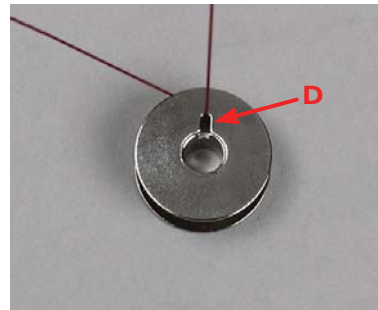

Inserting a bobbin

1. Place a bobbin in the bobbin case making sure the thread winds clockwise.
2. Draw the thread through the slit (A) of the bobbin case.
3. Continue to draw the thread under the tension spring and through the opening (B).
4. Pull about 4" (10cm) of thread.

Inserting a bobbin into the hook

 **Switch off the main switch and unplug the machine.**

1. Lift the hook cover plate (A) up and remove it. Open the bobbin case cover (B).
2. Holding the latch on the bobbin case (see picture), position the bobbin case into the hook aligning the slot with the rib. The bobbin case should lock into place when the latch is released.
3. Close the bobbin case cover and the hook cover plate.

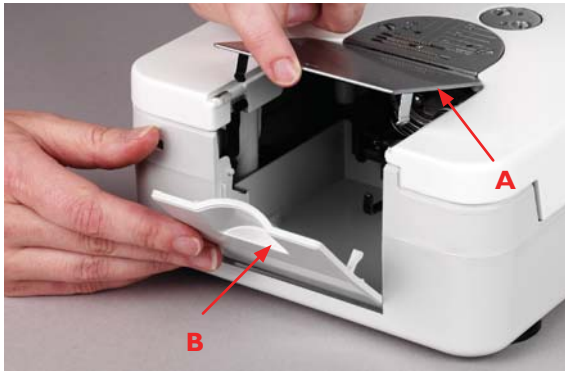

To remove bobbin case and bobbin

 **Switch off the main switch and unplug the machine.**

1. Raise the needle and presser foot. Lift the hook cover plate (A) up and remove it. Open the bobbin case cover (B).
2. Take the bobbin case out of the hook by pulling the latch and taking the bobbin case straight out of the hook.
3. To remove the bobbin, release the latch, and the bobbin will be released from the bobbin case.

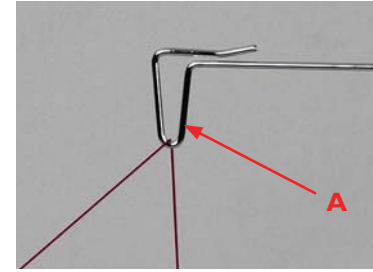

Threading the machine

1. Raise the presser foot lifter. Press the Needle Up/Down button twice to raise the needle to its highest position.

 **Switch off the main switch and unplug the machine.**

2. Place a thread spool on the spool pin.
3. Pass the thread through the guide on the thread guide bar (A) from the behind.
4. Pass the thread through the thread guide (B), then draw the thread between the pre-tension disks (C).

Note: The standard pre-tension dial setting is for the screw head to sink about 4 mm (1/8" to 3/16").

If you find that the thread is too loose while sewing, you can pass the thread through all three holes in the guide plate.

5. Holding the thread with both hands, draw the thread down and around the tension dial from right to left.
6. Pull the thread up to insert it between the tension disks (F) and pass it over the tail of the check spring (G). Pull the thread down over the loop of the check spring (H).

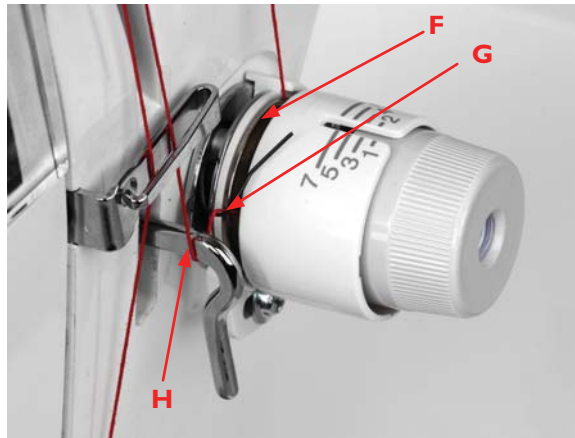

7. Draw the thread under the thread guide (H) and through the second thread guide (I). Pass the thread through the eye of the take-up lever (J).
8. Pass the thread through the thread guide (I) again.

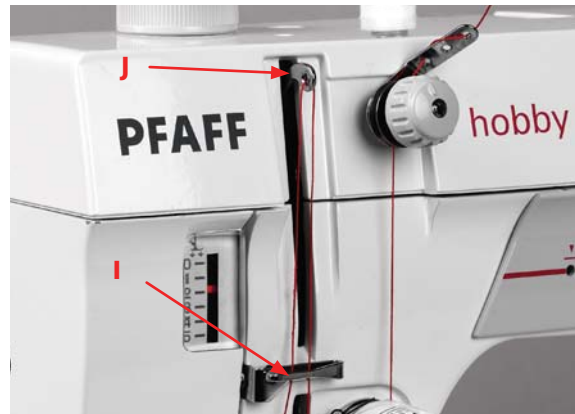

9. Slip the thread into the thread guide (K).
10. Draw the thread down to the needle bar thread guide (L), then pass the thread through the needle eye.

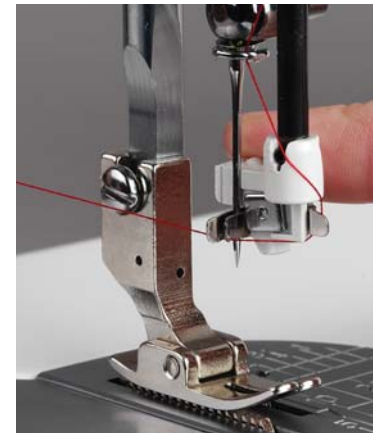
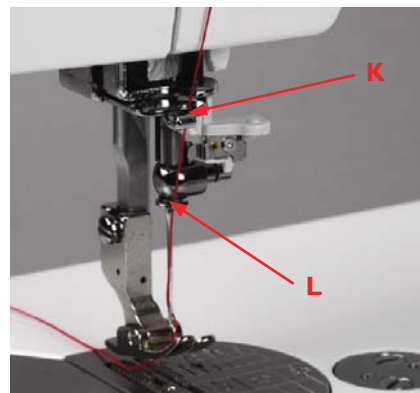

Needle threader

To make threading the needle easier and quicker you have been provided with a needle threader.

1. Lower the presser foot. Press the needle Up/Down button twice to raise the needle to its highest position.

 **Switch off the main switch and unplug the machine.**

2. Move the needle threader completely downwards and turn it towards the needle so that the small hook goes through the needle eye from the right.

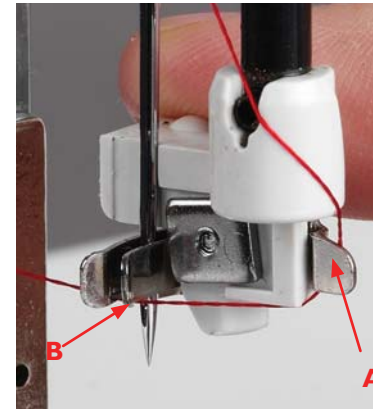

3. Pull the thread from behind around the guide (A) and under the hook (B).
4. Hold the end of the thread with your hand while pulling up the thread lightly.

5. Turn the knob (see picture). This will draw a thread loop through the needle. Release the threader knob slowly and then pull the thread loop to the right.

Note: When using the threads below the needle threader may not work.

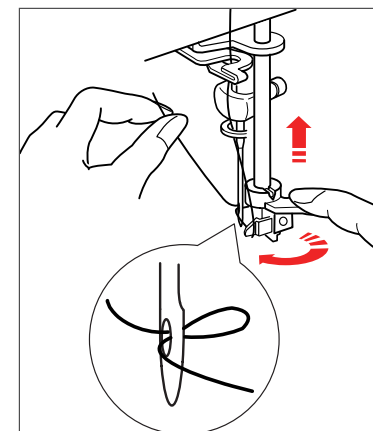

Needle size	Thread size
9/70	12, 20, 30, 40, 50, 60
11/80	12, 20, 30
14/100	12, 16, 20, 30
16/100	12, 20, 30

Bringing up the bobbin thread

1. Hold the thread with your left hand.
2. Turn the switch on. Press the Needle Up/Down button twice to pick up the bobbin thread.



 **Switch off the main switch and unplug the machine.**

3. Bring the bobbin thread up by pulling the needle thread.
4. Pull 4" (10cm) of both threads back and under the presser foot.



Balancing the Thread Tension

The thread tension should be adjusted depending on the sewing materials, layers of fabric and sewing method. To ensure perfect sewing results, the thread tension must be perfectly tuned. Set the required thread tension with the thread tension dial.

Balanced tension:



The ideal straight stitch has threads locked between two layers of fabric, as shown in the picture.

Thread tension is too tight:



If the needle thread tension is too high the threads are interlaced above the top fabric. Loosen the needle thread tension by turning the dial to the left.

Thread tension is too loose



If the needle thread tension is too low the threads are interlaced below the lower fabric. Tighten the needle thread tension by turning the dial to the right.

Attaching the extension table

Your GrandQuilter has been provided with an extension table to make it easier for you to work with large pieces of fabric.

On the underside of the extension table there are four table legs. Pull them all up to support the table.

Turn the table around and slide the extension table in the direction of the arrow in the picture, onto the machine.

Note : There is small door on the extension table which makes it possible for you to change the bobbin thread without having to remove the table. You can also store the knee lifter on the backside of the extension table.



Getting started

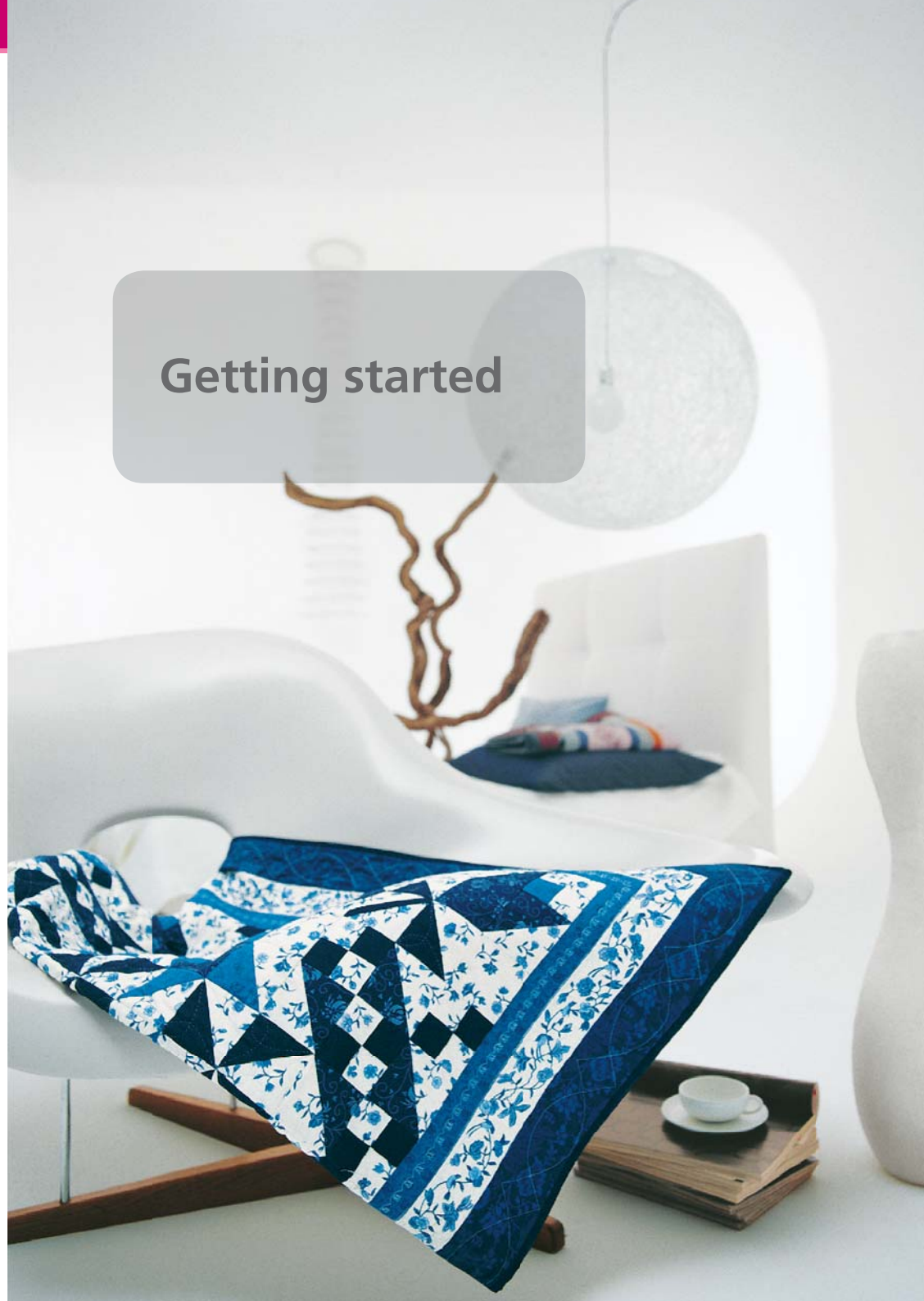

Getting started to sew

Before you start to sew, try test stitching with the same thread and with the same type of fabric.

1. Raise the presser foot and place the fabric under the foot.
2. Lower the needle into the fabric.
3. Lower the presser foot and pull the threads towards the back.
4. Set the speed control slide to slow until you get used to the speed. Press down on the foot control.
5. Gently guide the fabric along the seam guide letting the fabric feed by itself.
6. Check the sewing result and adjust the needle thread tension if needed.

Note: To lock the beginning of the seam, sew a few stitches forward, then sew a few stitches in reverse, then sew forward again. You can also pull the bobbin thread to bring the needle thread to the wrong side of the fabric. Tie the threads together. Trim the remaining threads.



Turning a corner

1. Stop the machine a few stitches before the end of the seam.
2. Press the Needle Up/Down button a few times until the needle falls on the end of the seam.
3. Raise the presser foot.
4. Pivot the fabric around the needle to change the sewing direction.
5. Lower the presser foot and continue sewing in the new direction.



Using the Fabric Guide

1. Attach the fabric guide to the attachment hole with the screw.
2. Adjust the position of the fabric guide and tighten the screw.
3. Place the fabric with its edge against the fabric guide.
4. Lower the presser foot and start to sew.

How to use the Free-motion foot

The Free-motion foot can be used when stippling or freehand quilting your quilt.

1. Place the darning plate (A) on top of the needle plate, matching the two holes in the needle plate with the two pins on the darning plate.
2. Attach the Free-motion foot to the presser bar with the lever over the needle clamp.
3. When using this foot, set the speed to the lowest to avoid jumpstitches.
4. Start to sew. Always test sew on a piece scrap fabric.

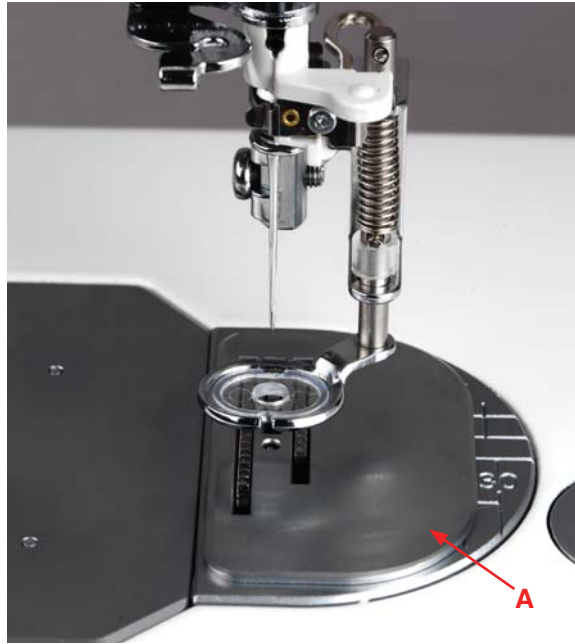

Quilting

Quilting is a traditional technique. A quilt consists of three layers, two layers of fabric with a layer of batting sandwiched between.

Stitch-in-the-Ditch

One way to hold the quilt top, batting and backing all together is using the "Stitch-in-the-Ditch" method of quilting. Stitching-in-the-ditch means stitching in the seams in the quilt blocks.

- Prepare your quilt by pin basting through all layers with safety pins – starting from the center of your quilt and working outward. Place a pin about every 6 – 8 inches (15 – 20 cm).
- To begin quilting, start sewing from the middle of the quilt and continue out. Starting from the center and sewing outward will help keep layers in place. Plan which seams you will actually stitch in. This stitching will not only hold the quilt together it will also create the pattern on the quilt back. You do not need to follow every seam in the quilt, sew every 3 – 4 inches to keep the quilt in place. Of course you can sew more to create a more decorative pattern for the back.

Note: Always test sew on scrap fabric before starting to sew to make sure your stitching is proper before you start quilting your piece.

Free-motion Stippling

Free-motion Stippling not only keeps the top, batting and backing together, but it also adds texture and interest to your quilt.

- Attach the Darning plate by placing it on top of the cover plate. Match the two pins in the Darning plate with the two holes in the needle plate.
- Attach the extension table to your sewing machine.
- Attach the Free-motion foot.
- Prepare your quilt by pin basting through all layers with safety pins – starting from the center of your quilt and working outward. Place a pin about every 10 – 12 inches (25 – 30 cm).
- Practice stippling on scraps of fabric and batting. When the feed dogs are covered, you move the fabric to determine the stitch length. Sewing with a constant speed will help to keep the stitches even. You should also lower the speed control slide in order to help make the stitches even.
- Begin near the center of your quilt. Take one stitch and pull the bobbin thread to the top of the quilt. Take a few stitches right next to one another to secure the threads. Now move the quilt so that your stitching creates scrolls and swirls. The stitching should not cross itself – but travel in swirling stitches all over the quilt.

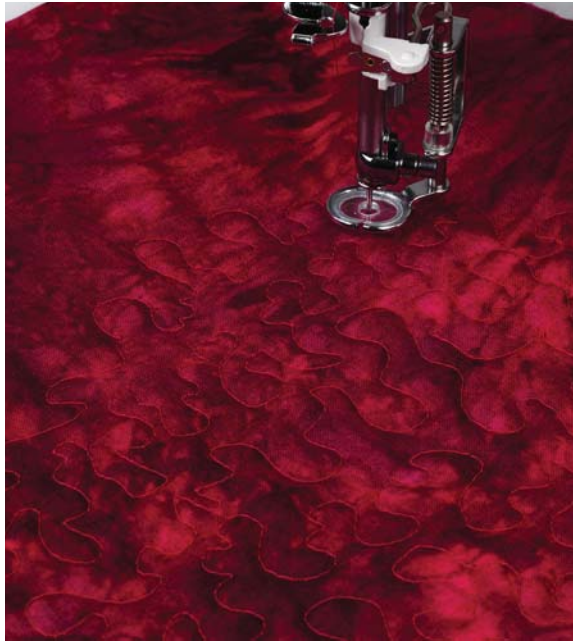

Maintenance and troubleshooting



Cleaning the hook and feed dogs

 Switch off the main switch and unplug the machine.

1. Remove the needle and presser foot.
2. Remove the hook cover plate (A) and open the bobbin case cover (B).
3. Loosen the setscrews (C) and remove the needle plate.
4. Clean the hook (D) and feed dogs (E) with the lint brush.
5. After cleaning the machine, attach the needle plate, needle and presser foot.

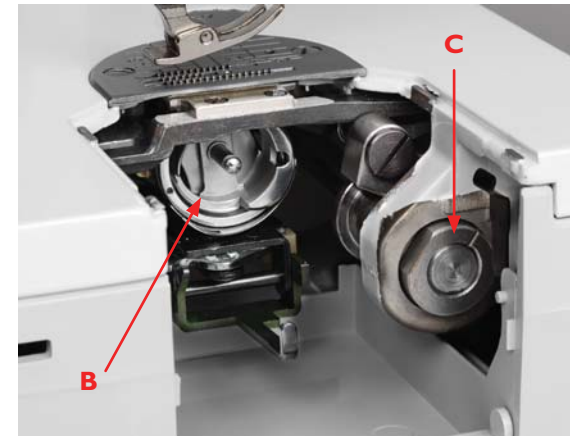
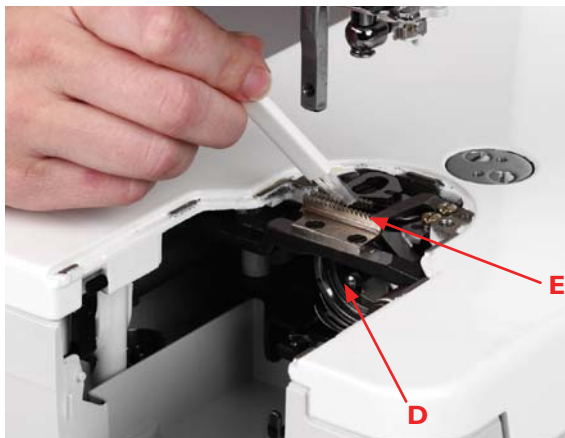
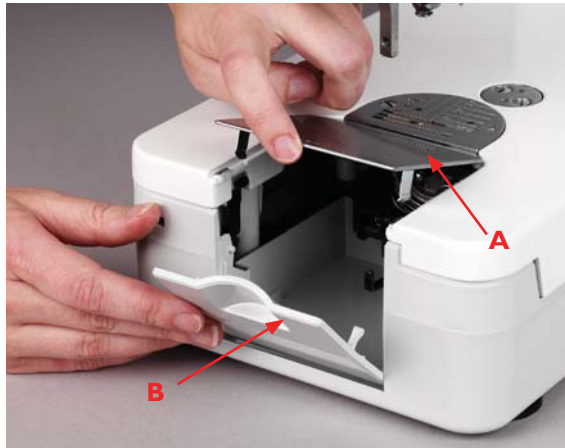

Oiling the machine

 Switch off the main switch and unplug the machine.

Add two or three drops of oil in the places shown (A), (B) and (C). You should only use the MO 70 sewing machine oil for your GrandQuilter.

If you use the machine frequently you should oil the machine once a day.

Use a soft, dry cloth to remove excess oil.

When you oil the hook race (B), remove the bobbin case from the hook.

After oiling, sew on a piece of scrap fabric to absorb excess oil.

Changing the light bulb

 **Switch off the main switch. If you have used the machine, wait for the lamp to cool before touching it.**

Removal:

Remove the setscrew (A).

Remove the face cover (B).

Pull out the light bulb (C) from the lamp socket (D).

Insertion:

Insert a new light bulb into the opening of the socket (D).

Attach the face cover (B) with the setscrew.

Note: Replace the bulb with the same type, rated 12 V, 5 W.

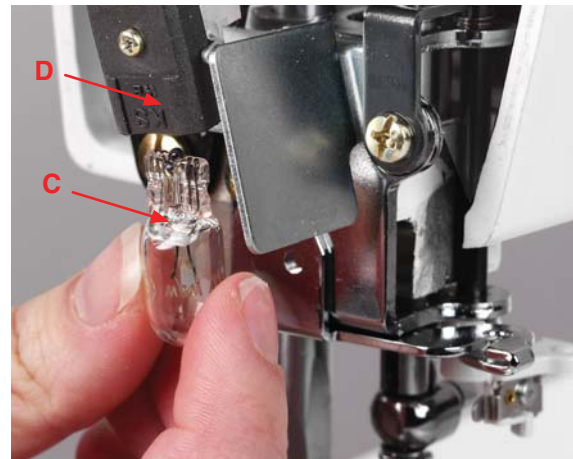

Troubleshooting

The needle thread breaks.

The needle thread is not threaded properly.	Page 21-23
The needle thread tension is too tight.	Page 25
The needle is bent or blunt.	Page 16
The needle is incorrectly inserted.	Page 16
The needle thread and the bobbin thread are not set under the presser foot when starting sewing.	Page 24
The threads were not pulled to the rear after sewing.	Page 24
The thread is too heavy or too fine for the needle.	Page 8

The bobbin thread breaks

The bobbin thread is not threaded properly in the bobbin holder.	Page 19
Lint has collected in the bobbin holder.	Page 34
The bobbin is damaged and does not turn smoothly.	Change the bobbin

The needle breaks

The needle is incorrectly inserted, bent or blunt.	Page 16
The needle clamp screw is loose.	Page 16
The threads were not pulled to the rear after sewing.	Page 24
The needle is too fine for the fabric being used.	Page 8
The needle and/or threads are not suitable for the work being sewn.	Page 8

The machine skips stitches

The needle is incorrectly inserted, bent or blunt.	Page 16
The needle thread is not threaded properly.	Page 21-23
A poor quality needle is used.	Change the needle
The needle thread tension is too tight.	Page 25
The needle and/or fabrics are not suitable for the work being sewn.	Page 8

Seam puckering

The needle thread is not threaded properly.	Page 21-23
The needle is too heavy for the fabric being sewn.	Page 8
The stitch length is too long for the fabric.	Page 14
The needle thread tension is too tight.	Page 25

The cloth is not fed smoothly

The feed dog is packed with lint.	Page 34
The stitches are too fine.	Page 14

Loops on the seams

The needle thread tension is too loose.	Page 25
The needle is too thick or too fine for the fabric.	Page 8

The machine does not sew or run

The machine is not plugged in.	Page 11
Thread has been caught in the hook race.	Page 34

The machine is noisy

Thread has been caught in the hook race.	Page 34
Lint has built up in the hook race or bobbin holder.	Page 34
The machine needs oiling.	Page 35

Important notes: Before changing presser foot and needle you must turn the main switch off. Do not attempt to sew without fabric under the presser foot.

When leaving the machine, even for only a short time, switch off the main switch. This is important if there are any children nearby.

Index**A**

Accessories	6-7
Accessories box	6
Attaching the darning plate	17
Attaching the extension table	26
Attaching the knee lift	15

B

Balancing the thread tension	25
Bobbin	6, 13, 18-20
Bobbin case	19-20
Bobbin winding	13, 18-19
Bobbin winding button	13
Bobbin case cover	20
Bringing up the bobbin thread	24
Brush	6, 34
Bulb	36

C

Carrying handle	10
Changing the light bulb	36
Changing the needle	16
Changing the presser foot	16
Cleaning the hook and feed dogs	34
Connecting the foot control	11

D

Darning plate	17, 30
---------------	--------

E

Electrical connection	11
Extension table	26
Extra accessories	7

F

Feed dogs	17, 34
Foot control	11-12
Free-motion foot	6, 30
Free-motion stippling	32

G

Getting started to sew	28
------------------------	----

H

Hook	20, 34-35
Hook cover plate	4-5, 20, 34

I

Inserting a bobbin	19
Inserting a bobbin into the hook	20

K

Knee lift	15, 26
-----------	--------

L

Leather foot	7
Light bulb	36

M

Machine overview	4-5
Maintenance	33
Main switch	4-5, 11, 16-17, 20-21, 23-24, 34-36

N

Needle	4-6, 8
Needle chart	8
Needle plate	4-5, 16
Needle size	8
Needle treader	23
Needle Up/Down	13

O

Oil	6, 35
Oiling the machine	35
Overview	4-5

P

Placing a tread cone on the spool pin	17
Pressure dial	15
Presser foot	4-5, 16
Presser foot lift	14
Problems and solutions	37-38

Q

Quilting	31
----------	----

R

Raise presser foot	14, 15
Remove the bobbin case and bobbin	20
Reverse lever	14
Revers sewing	14
Rolled hem foot	7

S

Sewing speed	12
Silk foot	7
Soft cover	10
Speed control slide	12
Spool pin	4-5, 17
Spool cap	6, 17
Standard accessories	6
Stippling	32
Stitch balance	25
Stitch-in-the-ditch	31
Stich length	14
Stitch length dial	14

T

Thread cone	6, 17
Thread cutter	4-5, 13
Thread guide	4-5, 18-19, 21-22
Thread spool	17
Thread tension	21-22, 25
Threading the machine	21-22
Troubleshooting	37-38
Turning a corner	13, 29

U

Using the Fabric guide	29
------------------------	----

V

Velvet foot	7
-------------	---

W

Walking foot	7
--------------	---

Z

Zipper foot	7
-------------	---

We reserve the right to change the machine equipment and assortment of accessories without prior notice, or make modifications to the performance or design.

Such modifications, however, will always be to the benefit of the user and the product.

